

Mini User Guide

© Copyright 2009 Hewlett-Packard
Development Company, L.P.

Bluetooth is a trademark owned by its proprietor and used by Hewlett-Packard Company under license. SD Logo is a trademark of its proprietor. Microsoft and Windows are U.S. registered trademarks of Microsoft Corporation.

The information contained herein is subject to change without notice. The only warranties for HP products and services are set forth in the express warranty statements accompanying such products and services. Nothing herein should be construed as constituting an additional warranty. HP shall not be liable for technical or editorial errors or omissions contained herein.

First Edition: December 2009

Document Part Number: 584528-001

Product notice

This user guide describes features that are common to most models. Some features may not be available on your computer.

To obtain the latest information in the *Mini User Guide*, go to the HP Web site at <http://www.hp.com/support>.

Safety warning notice

-
- ⚠ **WARNING!** To reduce the possibility of heat-related injuries or of overheating the computer, do not place the computer directly on your lap or obstruct the computer air vents. Use the computer only on a hard, flat surface. Do not allow another hard surface, such as an adjoining optional printer, or a soft surface, such as pillows or rugs or clothing, to block airflow. Also, do not allow the AC adapter to contact the skin or a soft surface, such as pillows or rugs or clothing, during operation. The computer and the AC adapter comply with the user-accessible surface temperature limits defined by the International Standard for Safety of Information Technology Equipment (IEC 60950).
-

Table of contents

1 Getting started

Using HP QuickWeb (select models only)	2
--	---

2 Knowing the parts

Identifying the hardware	3
Top components	3
TouchPad	3
Lights	4
Keys	5
Front components	5
Right-side components	6
Left-side components	7
Display components	8
Bottom components	9
Removing the bottom panel	9
Wireless antennas	10
Additional hardware components	11
Identifying the labels	11

3 Power management

Setting power options	13
Using power-saving states	13
Initiating and exiting Sleep	13
Initiating and exiting Hibernation	14
Using power plans	14
Viewing the current power plan	14
Selecting a different power plan	14
Customizing power plans	15
Setting password protection upon exiting Sleep or Hibernation	15
Using external AC power	15
Connecting the AC adapter	16
Using battery power	16
Displaying the remaining battery charge	17
Finding battery information in Help and Support	17

Using Battery Check	17
Inserting or removing the battery	17
Charging a battery	18
Maximizing battery discharge time	19
Managing low battery levels	19
Identifying low battery levels	19
Resolving a low battery level	20
Resolving a low battery level when external power is available	20
Resolving a low battery level when a charged battery is available	20
Resolving a low battery level when no power source is available	20
Resolving a low battery level when the computer cannot exit Hibernation	20
Calibrating a battery	20
Step 1: Fully charge the battery	20
Step 2: Disable Hibernation and Sleep	21
Step 3: Discharge the battery	21
Step 4: Fully recharge the battery	22
Step 5: Reenable Hibernation and Sleep	22
Conserving battery power	22
Storing a battery	23
Disposing of a used battery	23
Shutting down the computer	23

4 Internet

Connecting to a wired network	26
Connecting to a wireless network	27
Using wireless devices	27
Identifying wireless and network icons	27
Using the wireless controls	28
Using the wireless action key	28
Using HP Connection Manager (select models only)	28
Using Wireless Assistant software	29
Using operating system controls	29
Using a WLAN	29
Setting up a WLAN	30
Protecting your WLAN	30
Connecting to a WLAN	31
Roaming to another network	32
Using HP Mobile Broadband (select models only)	33
Inserting a SIM	33
Removing a SIM	34
Using Bluetooth wireless devices	36

Bluetooth and Internet Connection Sharing (ICS)	36
---	----

5 Multimedia

Multimedia features	37
Identifying your multimedia components	37
Adjusting the volume	39
Using the media activity action keys	41
Multimedia software	41
Using preinstalled multimedia software	42
Installing multimedia software from the Internet	42
Audio	43
Connecting external audio devices	43
Checking your audio functions	43
Video	44
Connecting an external monitor or projector	44
Webcam	45

6 Security

Protecting the computer	46
Using passwords	46
Setting passwords in Windows	47
Setting passwords in Setup Utility	47
Administrator password	48
Managing an administrator password	48
Entering an administrator password	48
Power-on password	48
Managing a power-on password	49
Entering a power-on password	49
Using antivirus software	50
Using firewall software	51
Installing critical updates	52

7 Digital cards

Inserting a digital card	53
Removing a digital card	54

8 USB devices

Using a USB device	55
Connecting a USB device	55
Removing a USB device	55

9 Pointing devices and keyboard

Setting pointing device preferences	57
Using the TouchPad	57
Scrolling	57
Pinching	58
Rotating	58
Connecting an external mouse	59
Using the keyboard	59
Using the action keys	59
Using hotkeys	60
Using the touch screen (select models only)	62
Tapping (or clicking)	62
Flicking	62
Dragging	62
Scrolling	62
Rotating	63
Pinching	63
Setting touch screen preferences	64

10 Drives

Identifying installed drives	65
Handling drives	65
Using external drives	66
Using optional external devices	67

11 Memory modules

12 Updating software

Updating the BIOS	73
Determining the BIOS version	73
Downloading a BIOS update	73
Updating programs and drivers	75

13 Changing QuickWeb settings

Disabling and enabling QuickWeb	76
---------------------------------------	----

14 Setup Utility

Starting Setup Utility	77
Using Setup Utility	77
Changing the language of Setup Utility	77
Navigating and selecting in Setup Utility	77
Displaying system information	78

Restoring default settings in Setup Utility	78
Exiting Setup Utility	78
Setup Utility menus	79
Main menu	79
Security menu	79
System Configuration menu	79
Diagnostics menu	80
Index	81

1 Getting started

Your computer's main operating system is Microsoft® Windows®. Your computer may also feature HP QuickWeb (select models only).

- The Microsoft Windows operating system displays the desktop on the display and controls your computer's hardware, peripherals, and software programs.
- If your computer includes QuickWeb, it allows you to quickly browse the Internet, view digital photos, listen to music, or keep in touch using e-mail, instant messages, or Skype (select models only), without having to start your main operating system. QuickWeb is also referred to as Instant-On Software (IOS).

 **NOTE:** To disable or reenale QuickWeb, refer to the “Changing QuickWeb settings” chapter. You can access the software Help when you are in QuickWeb by clicking the Help icon in the notification area.

Using HP QuickWeb (select models only)

To start QuickWeb:

1. Turn on your computer. The HP QuickWeb Home screen appears.
2. Click an icon on the QuickWeb Home screen to launch a program.

To start QuickWeb from Microsoft Windows:

- ▲ Select **Start**, click the arrow next to the Shut down button, and then click **Restart**. Your computer restarts and displays the HP QuickWeb Home screen.

 **NOTE:** To learn more about HP QuickWeb, refer to the software Help included with QuickWeb.

2 Knowing the parts

Identifying the hardware

Components included with the computer may vary by region and model. The illustrations in this chapter identify the standard features on most computer models.

To see a list of hardware installed in the computer:

- ▲ Select **Start > Control Panel > System and Security**. Click **System**, and then click **Device Manager**.

You can also add hardware or modify computer configurations using Device Manager.

Top components

TouchPad

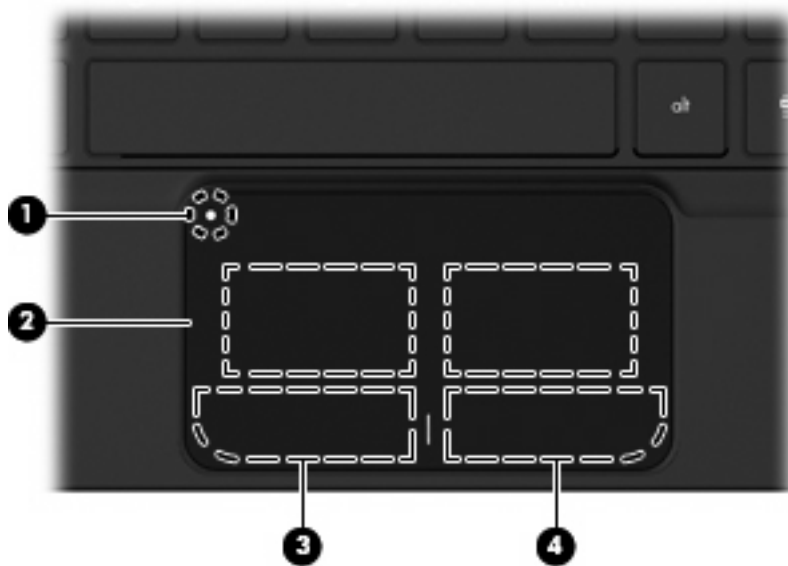





Component	Description
(1)  TouchPad on/off button	Turns the TouchPad on and off. Quickly double-tap the button to turn the TouchPad on and off.
(2) TouchPad*	Moves the pointer and selects or activates items on the screen.
(3) Left TouchPad button*	Functions like the left button on an external mouse.

(4)	Right TouchPad button*	Functions like the right button on an external mouse.
-----	------------------------	---

*This table describes factory settings. To view or change pointing device preferences, select **Start > Devices and Printers**. Then, right-click the icon representing your device, and select **Mouse settings**.



Lights

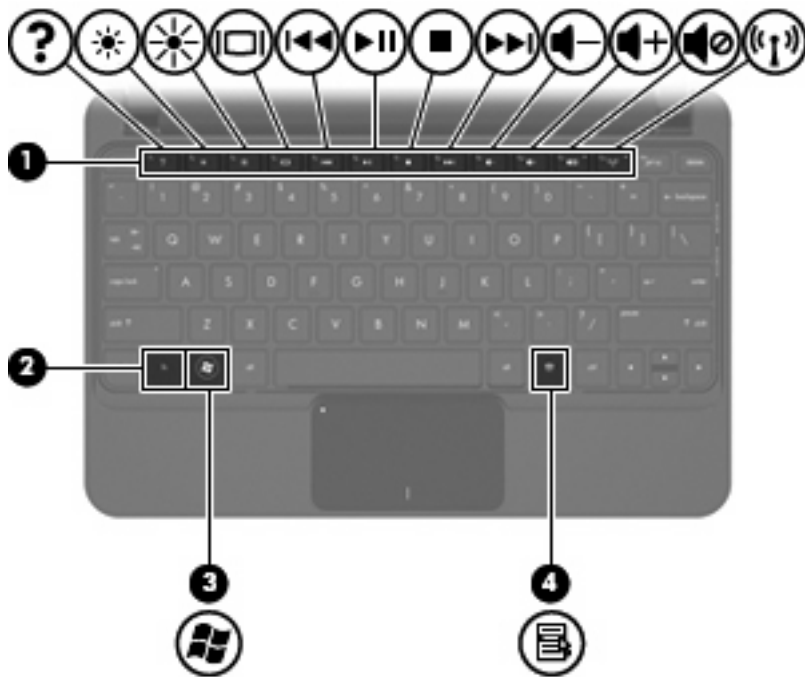

Component	Description
(1)  TouchPad light	<ul style="list-style-type: none"> On: The TouchPad is disabled. Off: The TouchPad is enabled.
(2)  Caps lock light	On: Caps lock is on.
(3)  Mute light	On: Speaker sound is off.
(4)  Wireless light	<ul style="list-style-type: none"> White: An integrated wireless device, such as a wireless local area network (WLAN) device and/or a Bluetooth® device, is on. <p>NOTE: Wireless devices are enabled at the factory.</p> <ul style="list-style-type: none"> Off: All wireless devices are off.

Keys



Component	Description
(1) Action keys	Execute frequently used system functions.
(2) <code>fn</code> key	Executes frequently used system functions when pressed in combination with a function key or the <code>esc</code> key.
(3)  Windows® logo key	Displays the Windows Start menu.
(4)  Windows applications key	Displays a shortcut menu for items beneath the pointer.



Front components



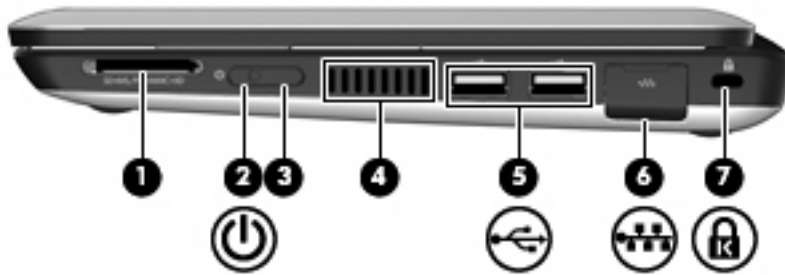

Component	Description
(1) Speakers (2)	Produce sound.

Right-side components









Component	Description
(1) Digital Media Slot	<p>Supports the following optional digital card formats:</p> <ul style="list-style-type: none"> • Memory Stick (MS) • MS/Pro • MultiMediaCard (MMC) • Secure Digital High Capacity (SDHC) Memory Card (standard and large size) • xD-Picture card
(2)  Power switch	<ul style="list-style-type: none"> • When the computer is off, slide the switch to turn on the computer. • When the computer is on, briefly slide the switch to initiate Sleep. • When the computer is in the Sleep state, briefly slide the switch to exit Sleep. • When the computer is in Hibernation, briefly slide the switch to exit Hibernation. <p>If the computer has stopped responding and Windows shutdown procedures are ineffective, slide and hold the power switch for at least five seconds to turn off the computer.</p> <p>To learn more about your power settings, select Start > Control Panel > System and Security > Power Options.</p>
(3) Power light	<ul style="list-style-type: none"> • White: The computer is on. • Blinking white: The computer is in the Sleep state. • Off: The computer is off or in Hibernation.
(4) Vent	<p>Enables airflow to cool internal components.</p> <p>NOTE: The computer fan starts up automatically to cool internal components and prevent overheating. It is normal for the internal fan to cycle on and off during routine operation.</p>
(5)  USB ports (2)	<p>Connect optional USB devices.</p>

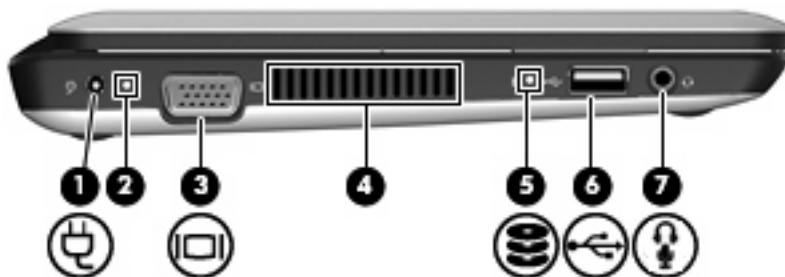

Component	Description
(6)  RJ-45 (network) jack and cover	Connects a network cable.
(7)  Security cable slot	Attaches an optional security cable to the computer.

NOTE: The security cable is designed to act as a deterrent, but it may not prevent the computer from being mishandled or stolen.

Left-side components



Component	Description
(1)  Power connector	Connects an AC adapter.
(2)  Battery light	<ul style="list-style-type: none"> Off: The computer is running on battery power. Blinking white: The battery has reached a low battery level, a critical battery level, or there is a battery error. When the battery reaches a critical battery level, the battery light begins blinking rapidly. Amber: A battery is charging. White: The computer is connected to external power and the battery is fully charged.
(3)  External monitor port	Connects an optional external display, such as a monitor or projector, to the computer.
(4)  Vent	Enables airflow to cool internal components.
(5)  Drive light	<ul style="list-style-type: none"> Blinking white: The hard drive is being accessed. Amber (select models only): HP ProtectSmart Hard Drive Protection has temporarily parked the hard drive.

Component	Description
(6)  USB port	Connects an optional USB device.
(7)  Audio-out (headphone) jack/Audio-in (microphone) jack	Produces sound when connected to optional powered stereo speakers, headphones, earbuds, a headset, or television audio. Also connects an optional headset microphone.

NOTE: When an audio component is connected to the jack, the computer speakers are disabled.

The audio component cable must have a 4-conductor connector.

Display components



Component	Description
(1) Internal display switch	Initiates Sleep if the display is closed while the power is on.
(2) Webcam light	On: The webcam is in use.

Component	Description
(3) Webcam	Records video and captures still photographs. NOTE: To capture and edit videos, you can use the preinstalled Arcsoft WebCam Companion 3 software.
(4)  Internal microphone	Records sound.

Bottom components

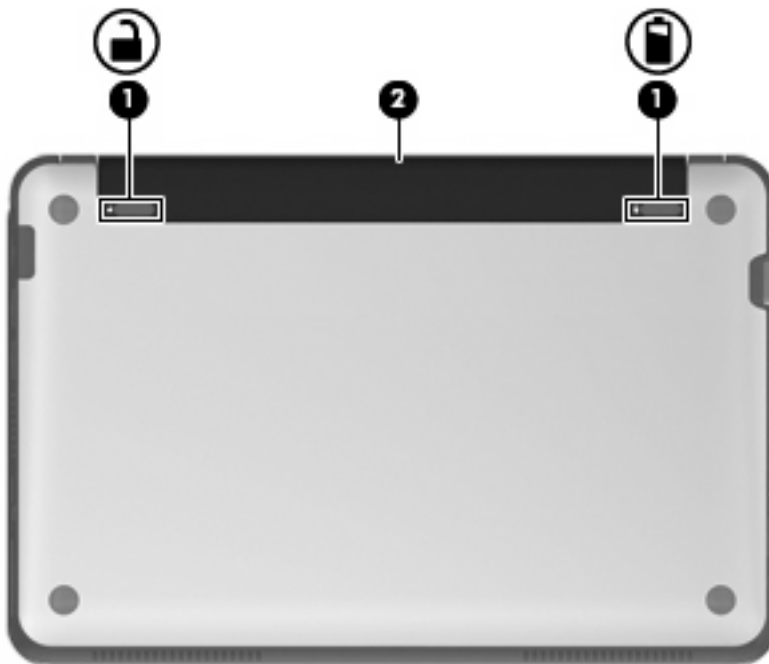

Component	Description
(1)  Battery release latches (2)	Release the battery from the battery bay and locks the battery in the battery bay.
(2) Battery bay	Holds the battery.

Removing the bottom panel

Removing the bottom panel allows access to the memory module compartment, SIM card insertion slot, regulatory label, and other important components. To remove the bottom panel:

1. Disconnect the computer from AC power.
2. Remove the battery (1).

 **NOTE:** For more information, refer to the section “Inserting or removing the battery,” later in this chapter.

3. Press the inner release latches (2) on the left and right sides to loosen the bottom panel.
4. Pull away the bottom panel (3).

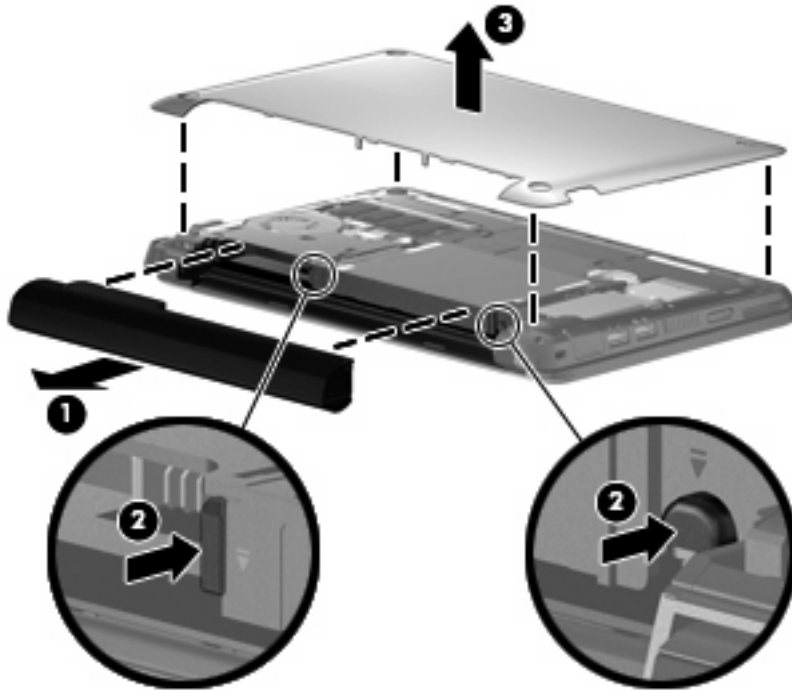

Wireless antennas

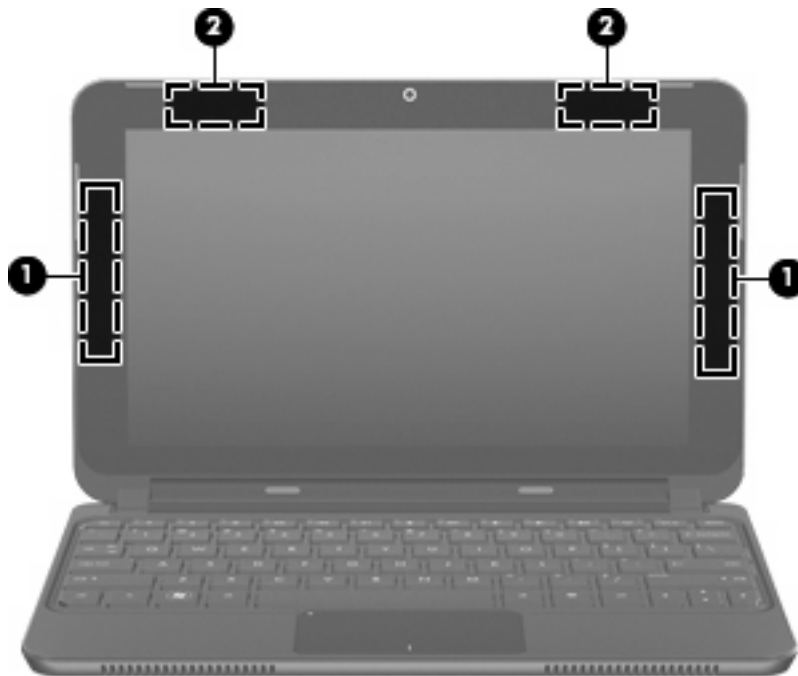

Component	Description
(1) WWAN antennas (2) (select models only)*	Send and receive wireless signals to communicate with wireless wide-area networks (WWANs).

Component	Description
(2) WLAN antennas (2)*	Send and receive wireless signals to communicate with wireless local-area networks (WLANs).
*The antennas are not visible from the outside of the computer. For optimal transmission, keep the areas immediately around the antennas free from obstructions.	

To see wireless regulatory notices, refer to the section of the *Regulatory, Safety and Environmental Notices* that applies to your country or region. These notices are located in Help and Support.

Additional hardware components



Component	Description
(1) Power cord*	Connects an AC adapter to an AC outlet.
(2) AC adapter	Converts AC power to DC power.
(3) Battery*	Powers the computer when the computer is not plugged into external power.
*Batteries and power cords vary in appearance by region and country.	

Identifying the labels

The labels affixed to the computer provide information you may need when you troubleshoot system problems or travel internationally with the computer.

- Service tag—Provides important information including the following:



- Product name **(1)**. This is the product name affixed to the front of your computer.
- Serial number (s/n) **(2)**. This is an alphanumeric identifier that is unique to each product.
- Part Number/Product number (p/n) **(3)**. This number provides specific information about the hardware components of the product. The part number helps a service technician to determine what components and parts are needed.
- Model description **(4)**. This is the alphanumeric identifier you use to locate documents, drivers, and support for your computer.
- Warranty period **(5)**. This number describes the duration (in years) of the warranty period for this computer.

Have this information available when you contact technical support. The service tag label is located inside the battery bay of your computer.

- Microsoft® Certificate of Authenticity—Contains the Windows® Product Key. You may need the Product Key to update or troubleshoot the operating system. This certificate is located under the bottom panel of the computer. To access the regulatory label in your computer, refer to the section “Removing the bottom panel,” earlier in this chapter.
- Regulatory label—Provides regulatory information about the computer, including the following:
 - Information about optional wireless devices and the approval markings of some of the countries or regions in which the devices have been approved for use. An optional device may be a wireless local area network (WLAN) device. You may need this information when traveling internationally.
 - The serial number of your HP Mobile Broadband Module (select models only).

The regulatory label is located under the bottom panel of the computer. To access the regulatory label in your computer, refer to the section “Removing the bottom panel,” earlier in this chapter.

3 Power management

Setting power options

Using power-saving states

The computer has two power-saving states enabled at the factory: Sleep and Hibernation.

When Sleep is initiated, the power light blinks and the screen clears. Your work is saved to memory, letting you exit the Sleep state faster than exiting Hibernation. If the computer is in the Sleep state for an extended period or if the battery reaches a critical battery level while in the Sleep state, the computer initiates Hibernation.

When Hibernation is initiated, your work is saved to a hibernation file on the hard drive and the computer turns off.

△ **CAUTION:** To prevent possible audio and video degradation, loss of audio or video playback functionality, or loss of information, do not initiate Sleep or Hibernation while reading from or writing to a disc or an external media card.

📝 **NOTE:** You cannot initiate any type of networking connection or perform any computer functions while the computer is in the Sleep state or in Hibernation.

Initiating and exiting Sleep

The system is set at the factory to initiate Sleep after 15 minutes of inactivity when running on battery power and 30 minutes of inactivity when running on external power.

Power settings and timeouts can be changed using Power Options in Windows Control Panel.

With the computer on, you can initiate Sleep in any of the following ways:

- Briefly slide the power switch.
- Close the display.
- Click **Start**, click the arrow next to the Shut down button, and then click **Sleep**.

You can exit Sleep in any of the following ways:

- Briefly slide the power switch.
- If the display is closed, open the display and activate the TouchPad.
- Press a key on the keyboard.

When the computer exits Sleep, the power light turns on and your work returns to the screen where you stopped working.

 **NOTE:** If you have set a password to be required when the computer exits Sleep, you must enter your Windows password before your work returns to the screen.

Initiating and exiting Hibernation

Power settings and timeouts can be changed using Power Options in Windows Control Panel.

To initiate Hibernation:

- ▲ Click **Start**, click the arrow next to the Shut down button, and then click **Hibernate**.

To exit Hibernation:

- ▲ Briefly slide the power switch.

When the computer exits Hibernation, the power light turns on and your work returns to the screen where you stopped working.

 **NOTE:** If you have set a password to be required when the computer exits Hibernation, you must enter your Windows password before your work returns to the screen.

Using power plans

A power plan is a collection of system settings that manages how the computer uses power. Power plans can help you conserve power and maximize computer performance.

The following power plans are available:

- HP recommended
- High performance
- Power saver

You can change the settings of these power plans through Power Options.

Viewing the current power plan

- ▲ Click the **Battery Meter** icon in the notification area, at the far right of the taskbar.

– or –

Select **Start > Control Panel > System and Security > Power Options**.

Selecting a different power plan

- ▲ Click the **Battery Meter** icon in the notification area, and then select a power plan from the list.

– or –

Select **Start > Control Panel > System and Security > Power Options**, and then select a power plan from the list.

Customizing power plans

1. Click the **Battery Meter** icon in the notification area and then click **Power options**.
– or –
Select **Start > Control Panel > System and Security > Power Options**.
2. Select a power plan, and then click **Change plan settings**.
3. Change the settings as needed.
4. To change additional settings, click **Change advanced power settings** and make your changes.

Setting password protection upon exiting Sleep or Hibernation

To set the computer to prompt for a password when the computer exits Sleep or Hibernation, follow these steps:

1. Select **Start > Control Panel > System and Security > Power Options**.
2. In the left pane, click **Require a password on wakeup**.
3. Click **Change Settings that are currently unavailable**.
4. Click **Require a password (recommended)**.
5. Click **Save changes**.

Using external AC power

External AC power is supplied through an approved AC adapter.

- ⚠ **WARNING!** To reduce potential safety issues, use only the AC adapter provided with the computer, a replacement AC adapter provided by HP, or a compatible AC adapter purchased from HP.

Connect the computer to external AC power under any of the following conditions:

- ⚠ **WARNING!** Do not charge the battery while you are onboard aircraft.

- When you are charging or calibrating a battery
- When you are installing or modifying system software
- When you are writing information to a CD or DVD

When you connect the computer to external AC power, the following events occur:

- The battery begins to charge.
- If the computer is turned on, the Battery Meter icon in the notification area changes appearance.

When you disconnect external AC power, the following events occur:

- The computer switches to battery power.
- The display brightness is automatically decreased to save battery life. Press the **f3** action key to increase brightness or reconnect the AC adapter.

Connecting the AC adapter

⚠ WARNING! To reduce the risk of electric shock or damage to the equipment:

Plug the power cord into an AC outlet that is easily accessible at all times.

Disconnect power from the computer by unplugging the power cord from the AC outlet (not by unplugging the power cord from the computer).

If provided with a 3-pin attachment plug on the power cord, plug the cord into a grounded (earthed) 3-pin outlet. Do not disable the power cord grounding pin, for example, by attaching a 2-pin adapter. The grounding pin is an important safety feature.

To connect the computer to external AC power, follow these steps:

1. Plug the AC adapter into the power connector **(1)** on the computer.
2. Plug the power cord into the AC adapter **(2)**.
3. Plug the other end of the power cord into an AC outlet **(3)**.

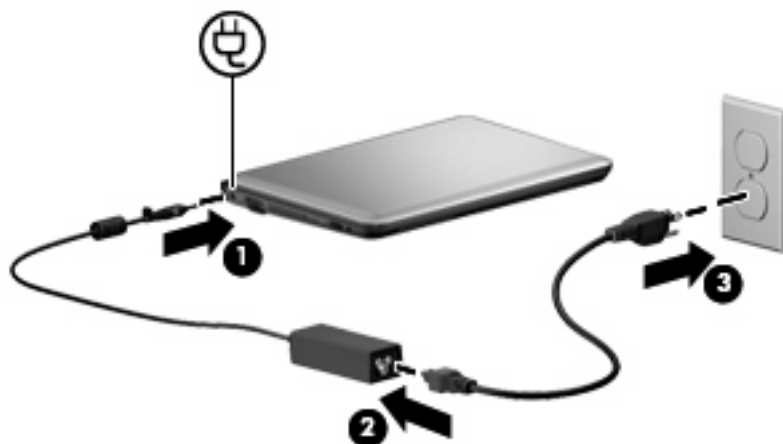

Using battery power

When a charged battery is in the computer and the computer is not plugged into external power, the computer runs on battery power. When the computer is plugged into external AC power, the computer runs on AC power.

If the computer contains a charged battery and is running on external AC power supplied through the AC adapter, the computer switches to battery power if the AC adapter is disconnected from the computer.

📝 NOTE: The display brightness is decreased to save battery life when you disconnect AC power. To increase brightness, use the **f3** action key or reconnect the AC adapter.

You can keep a battery in the computer or in storage, depending on how you work. Keeping the battery in the computer whenever the computer is plugged into AC power charges the battery and also protects your work in case of a power outage. However, a battery in the computer slowly discharges when the computer is off and unplugged from external power.

⚠ WARNING! To reduce potential safety issues, use only the battery provided with the computer, a replacement battery provided by HP, or a compatible battery purchased from HP.

Battery life varies, depending on power management settings, programs running on the computer, display brightness, external devices connected to the computer, and other factors.

Displaying the remaining battery charge

- ▲ Move the pointer over the **Battery Meter** icon in the notification area, at the far right of the taskbar.

Finding battery information in Help and Support

Help and Support provides the following tools and information about the battery:

- Battery Check tool to test battery performance
- Information on calibration, power management, and proper care and storage to maximize battery life
- Information on battery types, specifications, life cycles, and capacity

To access battery information:

- ▲ Select **Start > Control Panel > Hardware and Sound > Power Options > Tell me more about power plans**.

Using Battery Check

Help and Support provides information on the status of the battery installed in the computer.

To run Battery Check:

1. Connect the AC adapter to the computer.

 **NOTE:** The computer must be connected to external power for Battery Check to function properly.

2. Select **Start > Help and Support > Troubleshoot > Power, Thermal and Mechanical**.
3. Click the **Power** tab, and then click **Battery Check**.

Battery Check examines the battery and its cells to see if they are functioning properly, and then reports the results of the examination.

Inserting or removing the battery

- △ **CAUTION:** Removing a battery that is the sole power source may cause loss of information. To prevent loss of information, save your work and initiate Hibernation or shut down the computer through Windows before removing the battery.

To insert the battery:

1. Turn the computer upside down on a flat surface.

2. Align the tabs on the battery with the notches on the computer, and then insert the battery into the battery bay. The battery release latches automatically lock the battery into place.



To remove the battery:

1. Turn the computer upside down on a flat surface.
2. Slide the battery release latches (1) to release the battery, and then remove the battery (2).



Charging a battery

⚠ WARNING! Do not charge the computer battery while you are onboard aircraft.

The battery charges whenever the computer is plugged into external power through an AC adapter.

The battery charges whether the computer is off or in use, but it charges faster when the computer is off.

Charging may take longer if a battery is new, has been unused for 2 weeks or more, or is much warmer or cooler than room temperature.

To prolong battery life and optimize the accuracy of battery charge displays, follow these recommendations:

- If you are charging a new battery, charge it fully before turning on the computer.
- Charge the battery until the battery light turns white.

 **NOTE:** If the computer is on while the battery is charging, the Battery Meter icon in the notification area may show 100 percent charge before the battery is fully charged.

- Allow the battery to discharge below 5 percent of a full charge through normal use before charging it.
- If the battery has been unused for one month or more, calibrate the battery instead of simply charging it.

The battery light displays charge status:

- Off: The computer is running on battery power.
- Blinking white: The battery has reached a low battery level, a critical battery level, or there is a battery error. When the battery reaches a critical battery level, the battery light begins blinking rapidly.
- Amber: A battery is charging.
- White: The computer is connected to external power and the battery is fully charged,

Maximizing battery discharge time

Battery discharge time varies depending on the features you use while on battery power. Maximum discharge time gradually shortens, as the battery storage capacity naturally degrades.

Tips for maximizing battery discharge time:

- Decrease the brightness on the display.
- Remove the battery from the computer when it is not being used or charged.
- Store the battery in a cool, dry location.

Managing low battery levels

The information in this section describes the alerts and system responses set at the factory. Some low-battery alerts and system responses can be changed using Power Options in Windows Control Panel. Preferences set using Power Options do not affect lights.

Identifying low battery levels

When a battery that is the sole power source for the computer reaches a low battery level, the battery light blinks.

If a low battery level is not resolved, the computer enters a critical battery level, and the battery light blinks rapidly.

The computer takes the following actions for a critical battery level:

- If Hibernation is enabled and the computer is on or in Sleep, the computer initiates Hibernation.
- If Hibernation is disabled and the computer is on or in Sleep, the computer remains briefly in Sleep, and then shuts down and loses any unsaved information.

Resolving a low battery level

 **CAUTION:** To reduce the risk of losing information when the computer reaches a critical battery level and has initiated Hibernation, do not restore power until the power light turns off.

Resolving a low battery level when external power is available

- ▲ Connect to an approved AC adapter.

Resolving a low battery level when a charged battery is available

1. Turn off the computer or initiate Hibernation.
2. Remove the discharged battery, and then insert a charged battery.
3. Turn on the computer.

Resolving a low battery level when no power source is available

- ▲ Initiate Hibernation.
– or –
Save your work and shut down the computer.

Resolving a low battery level when the computer cannot exit Hibernation

When the computer lacks sufficient power to exit Hibernation, follow these steps:

1. Insert a charged battery or plug the computer into external power.
2. Exit Hibernation by briefly sliding the power switch.

Calibrating a battery

Calibrate a battery under the following conditions:

- When battery charge displays seem inaccurate
- When you observe a significant change in battery run time

Even if a battery is heavily used, it should not need to be calibrated more than once a month. It is also not necessary to calibrate a new battery.

Step 1: Fully charge the battery

 **WARNING!** Do not charge the computer battery while you are onboard aircraft.

 **NOTE:** The battery charges whether the computer is off or in use, but it charges faster when the computer is off.

To fully charge the battery:

1. Insert the battery into the computer.
2. Connect the computer to an AC adapter and then plug the adapter into external power.
The battery light on the computer turns amber.
3. Leave the computer plugged into external power until the battery is fully charged.
The battery light on the computer turns white.

Step 2: Disable Hibernation and Sleep

1. Click the **Battery Meter** icon in the notification area, and then click **Power options**.
– or –
Select **Start > Control Panel > System and Security > Power Options**.
2. Under the current power plan, click **Change plan settings**.
3. Record the **Turn off the display** settings listed in the **On battery** column so that you can reset them after the calibration.
4. Change the **Turn off the display** settings to **Never**.
5. Click **Change advanced power settings**.
6. Click the plus sign next to **Sleep**, and then click the plus sign next to **Hibernate after**.
7. Record the **On battery** setting under **Hibernate after** so that you can reset it after the calibration.
8. Change the **On battery** setting to **Never**.
9. Click **OK**.
10. Click **Save changes**.

Step 3: Discharge the battery

The computer must remain on while the battery is being discharged. The battery can discharge whether or not you are using the computer, but the battery discharges faster while you are using it.

- If you plan to leave the computer unattended during the discharge, save your information before beginning the discharge procedure.
- If you use the computer occasionally during the discharge procedure and have set energy-saving timeouts, expect the following performance from the system during the discharge process:
 - The monitor does not turn off automatically.
 - Hard drive speed does not decrease automatically when the computer is idle.
 - System-initiated Hibernation does not occur.

To discharge a battery:

1. Unplug the computer from its external power source, but do *not* turn off the computer.
2. Run the computer on battery power until the battery is discharged. The battery light begins to blink amber when the battery has discharged to a low battery level. When the battery is discharged, the battery light turns off and the computer shuts down.

Step 4: Fully recharge the battery

To recharge the battery:

1. Plug the computer into external power and maintain external power until the battery is fully recharged. When the battery is recharged, the battery light on the computer turns white.

You can use the computer while the battery is recharging, but the battery charges faster if the computer is off.

2. If the computer is off, turn it on when the battery is fully charged and the battery light has turned white.

Step 5: Reenable Hibernation and Sleep

CAUTION: Failure to reenable Hibernation after calibration may result in a full battery discharge and information loss if the computer reaches a critical battery level.

1. Click the **Battery Meter** icon in the notification area, and then click **Power options**.
– or –
Select **Start > Control Panel > System and Security > Power Options**.
2. Under the current power plan, click **Change plan settings**.
3. Reenter the settings that you recorded for the items in the **On battery** column.
4. Click **Change advanced power settings**.
5. Click the plus sign next to **Sleep**, and then click the plus sign next to **Hibernate after**.
6. Reenter the setting that you recorded for **On battery**.
7. Click **OK**.
8. Click **Save changes**.

Conserving battery power

- Select the Power saver power plan through Power Options under System and Security in Windows Control Panel.
- Turn off wireless and local area network (LAN) connections and exit modem applications when you are not using them.
- Disconnect external devices that are not plugged into an external power source, when you are not using them.
- Stop, disable, or remove any external media cards that you are not using.

- Use the **f2** and **f3** action keys to adjust screen brightness as needed.
- If you leave your work, initiate Sleep or Hibernation, or shut down the computer.

Storing a battery

△ **CAUTION:** To prevent damage to a battery, do not expose it to high temperatures for extended periods of time.

If a computer is unused and unplugged from external power for more than 2 weeks, remove the battery and store it separately.

To prolong the charge of a stored battery, place it in a cool, dry place.

📝 **NOTE:** A stored battery should be checked every 6 months. If the capacity is less than 50 percent, recharge the battery before returning it to storage.

Calibrate a battery before using it if it has been stored for one month or more.

Disposing of a used battery

△ **WARNING!** To reduce the risk of fire or burns, do not disassemble, crush, or puncture; do not short external contacts; do not dispose of in fire or water.

Refer to the *Regulatory, Safety and Environmental Notices* for battery disposal information.

Shutting down the computer

△ **CAUTION:** Unsaved information will be lost when the computer is shut down.

The Shut down command closes all open programs, including the operating system, and then turns off the display and computer.

Shut down the computer under any of the following conditions:

- When you need to replace the battery or access components inside the computer
- When you are connecting an external hardware device that does not connect to a USB port
- When the computer is unused and disconnected from external power for an extended period

Although you can shut down the computer with the power switch, the recommended procedure is to use the Windows Shut down command.

To shut down the computer, follow these steps:

📝 **NOTE:** If the computer is in the Sleep state or in Hibernation, you must first exit Sleep or Hibernation before shut down is possible.

1. Save your work and close all open programs.
2. Click **Start**.
3. Click **Shut down**.

If the computer is unresponsive and you are unable to use the preceding shut down procedures, try the following emergency procedures in the sequence provided:

- Press `ctrl+alt+delete`, and then click the **Power** button.
- Slide and hold the power switch for at least 5 seconds.
- Disconnect the computer from external power and remove the battery.

4 Internet

Your computer supports the following types of Internet access:

- **Wired**—You can access the Internet by connecting to a broadband network using the RJ-45 (network) jack.
- **Wireless**—For mobile Internet access, you can use a wireless connection. To learn about setting up a wireless network or adding your computer to an existing network, refer to the “Connecting to a wireless network” section.

Connecting to a wired network

Connecting to a local area network (LAN) requires an 8-pin, RJ-45 network cable (purchased separately). If the network cable contains noise suppression circuitry (1), which prevents interference from TV and radio reception, orient the circuitry end of the cable (2) toward the computer.



To connect the network cable:

⚠ WARNING! To reduce the risk of electric shock, fire, or damage to the equipment, do not plug a modem cable or telephone cable into an RJ-45 (network) jack.

1. Plug the network cable into the network jack (1) on the computer.
2. Plug the other end of the cable into a network wall jack (2).

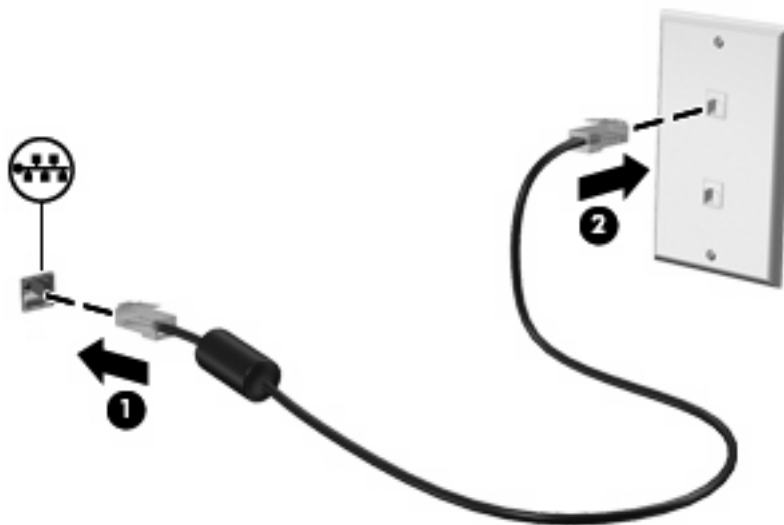

Connecting to a wireless network

Using wireless devices

Wireless technology transfers data across radio waves instead of wires. Your computer may be equipped with one or more of the following wireless devices:





- **Wireless local area network (WLAN) device**—Connects the computer to wireless local area networks (commonly referred to as Wi-Fi networks, wireless LANs, or WLANs) in corporate offices, your home, and public places such as airports, restaurants, coffee shops, hotels, and universities. In a WLAN, each mobile wireless device communicates with a wireless router or a wireless access point.
- **HP Mobile Broadband Module (select models only)**—A wireless wide area network (WWAN) device that provides access to information wherever mobile network operator service is available. In a WWAN, each mobile device communicates to a mobile network operator's base station. Mobile network operators install networks of base stations (similar to cell phone towers) throughout large geographic areas, effectively providing coverage across entire states, regions, or even countries.
- **Bluetooth® device**—Creates a personal area network (PAN) to connect to other Bluetooth-enabled devices such as computers, phones, printers, headsets, speakers, and cameras. In a PAN, each device communicates directly with other devices, and devices must be relatively close together—typically within 10 meters (approximately 33 feet) of each other.





The computer supports the following IEEE industry standards:

- **802.11b**, the first popular standard, supports data rates of up to 11 Mbps and operates at a frequency of 2.4 GHz.
- **802.11g** supports data rates of up to 54 Mbps and operates at a frequency of 2.4 GHz. An 802.11g WLAN device is backward compatible with 802.11b devices, so they can operate on the same network.

For more information on wireless technology, refer to the information and Web site links provided in Help and Support.

Identifying wireless and network icons

Icon	Name	Description
	Wireless (connected)	Identifies the location of the wireless lights and the wireless buttons on the computer. Also identifies the Wireless Assistant software on the computer and indicates that one or more of the wireless devices are on.
	Wireless (disconnected)	Identifies the Wireless Assistant software on the computer and indicates that all of the wireless devices are off.
	HP Connection Manager	Opens HP Connection Manager, which enables you to create a connection with an HP Mobile Broadband device (select models only).
	Wired network (connected)	Indicates that one or more of your network drivers are installed and one or more network devices are connected to the network.

	Network (connected)	Indicates that one or more of your network drivers are installed, one or more network devices are connected to a wireless network, and one or more network devices may be connected to a wired network.
	Network (disabled/ disconnected)	Indicates that one or more of your network drivers are installed, no wireless connections are available or all wireless network devices are disabled by the wireless button or Wireless Assistant, and no network devices are connected to a wired network.
	Network (disconnected)	Indicates that one or more of your network drivers are installed and wireless connections are available, but no network devices are connected to a wired or wireless network.
	Wired network (disabled/ disconnected)	Indicates that one or more of your network drivers are installed, all network devices or all wireless devices are disabled in Windows® Control Panel, and no network devices are connected to a wired network.

Using the wireless controls

You can control the wireless devices in your computer using these features:

- The **f12** wireless action key
- HP Connection Manager software (select models only)
- Wireless Assistant software (select models only)
- Operating system controls

Using the wireless action key

The computer has a wireless action key (**f12**), one or more wireless devices, and one wireless light. All of the wireless devices on your computer are enabled at the factory.

The wireless light indicates the overall power state of your wireless devices, not the status of individual devices. If the wireless light is white, at least one wireless device is on. If the wireless light is off, all wireless devices are off.

Because the wireless devices are enabled at the factory, you can use the wireless action key (**f12**) to turn on or turn off all of the wireless devices simultaneously.

Using HP Connection Manager (select models only)

You can use HP Connection Manager to connect to WWANs using the HP Mobile Broadband device in your computer (select models only).

- ▲ To start Connection Manager, click the **Connection Manager** icon in the notification area, at the far right of the taskbar.

– or –

Select **Start > All Programs > HP Connection Manager > HP Connection Manager**.

For more details about using Connection Manager, refer to the Connection Manager software Help.

Using Wireless Assistant software

A wireless device can be turned on or off using the Wireless Assistant software. If a wireless device is disabled by Setup Utility, it must be reenabled by Setup Utility before it can be turned on or off using Wireless Assistant.

 **NOTE:** Enabling or turning on a wireless device does not automatically connect the computer to a network or a Bluetooth-enabled device.

To view the state of the wireless devices, click the **Show hidden icons** icon, the arrow at the left of the notification area, and position the mouse pointer over the wireless icon.

If the wireless icon is not displayed in the notification area, complete the following steps to change Wireless Assistant properties:

1. Select **Start > Control Panel > Network and Internet > HP Wireless Assistant**.
2. Click **Properties**.
3. Select the check box next to **HP Wireless Assistant icon in notification area**.
4. Click **Apply**.
5. Click **Close**.

For more information, refer to the Wireless Assistant software Help:

1. Open Wireless Assistant by double-clicking the icon in the notification area.
2. Click the **Help** button.

You can use the properties dialog box in Wireless Assistant to show the on/off controls for each installed wireless device and control the devices separately. To show the on/off controls:

1. Double-click the **Wireless Assistant** icon in the notification area, at the far right of the taskbar.
2. Click **Properties**.
3. Select the **Independent controls for installed wireless devices** check box, and then click **Apply**.
4. Click **Turn off** or **Turn on** to control each wireless device separately.

Using operating system controls

Some operating systems also offer a way to manage integrated wireless devices and the wireless connection. For example, Windows provides the Network and Sharing Center that allows you to set up a connection or network, connect to a network, manage wireless networks, and diagnose and repair network problems.

- ▲ To access the Network and Sharing Center, select **Start > Control Panel > Network and Sharing Center**.

For more information, select **Start > Help and Support**.

Using a WLAN

With a WLAN device, you can access a wireless local area network (WLAN), which is composed of other devices and accessories that are linked by a wireless router or a wireless access point.

 **NOTE:** The terms *wireless router* and *wireless access point* are often used interchangeably.

- A large-scale WLAN, such as a corporate or public WLAN, typically uses wireless access points that can accommodate a large number of devices and accessories and can separate critical network functions.
- A home or small office WLAN typically uses a wireless router, which allows several wireless and wired devices to share an Internet connection, a printer, and files without requiring additional pieces of hardware or software.

To use the WLAN device in your computer, you must connect to a WLAN infrastructure (provided through a service provider or a public or corporate network).

Setting up a WLAN

To set up a WLAN and connect to the Internet, you need the following equipment:

- A broadband modem (either DSL or cable) **(1)** and high-speed Internet service purchased from an Internet service provider (ISP)
- A wireless router (purchased separately) **(2)**
- Computer equipped with a wireless device **(3)**

The illustration below shows an example of a wireless network installation that is connected to the Internet.

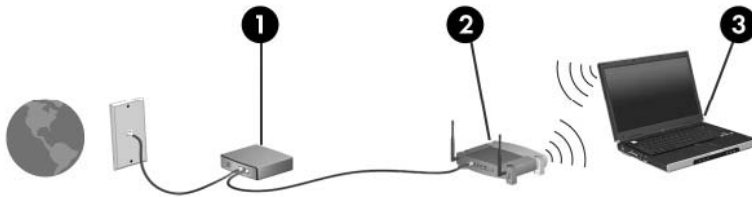

As your network grows, additional wireless and wired devices can be connected to the network to access the Internet.

For help in setting up your WLAN, refer to the information provided by your router manufacturer or your ISP.

Protecting your WLAN

It is essential to understand that because the WLAN standard was designed with only limited security capabilities—basically to foil casual eavesdropping rather than more powerful forms of attack—WLANs are vulnerable to well-known and well-documented security weaknesses.

WLANs in public areas, or “hotspots,” like coffee shops and airports may not provide any security. New technologies are being developed by wireless manufacturers and hotspot service providers that make the public environment more secure and anonymous. If you are concerned about the security of your computer in a hotspot, limit your network activities to noncritical e-mail and basic Internet surfing.

When you set up a WLAN or access an existing WLAN, always enable security features to protect your network from unauthorized access. The common security levels are Wi-Fi Protected Access (WPA)-Personal and Wired Equivalent Privacy (WEP). Because wireless radio signals travel outside the network, other WLAN devices can pick up unprotected signals and either connect to your network

(uninvited) or capture information being sent across it. However, you can take precautions to protect your WLAN:

- **Use a wireless transmitter with built-in security**

Many wireless base stations, gateways, or routers provide built-in security features such as wireless security protocols and firewalls. With the correct wireless transmitter, you can protect your network from the most common wireless security risks.

- **Work behind a firewall**

A firewall is a barrier that checks both data and requests for data that are sent to your network, and discards any suspicious items. Firewalls are available in many varieties, both software and hardware. Some networks use a combination of both types.

- **Use wireless encryption**

A variety of sophisticated encryption protocols is available for your WLAN. Find the solution that works best for your network security:

- **Wired Equivalent Privacy (WEP)** is a wireless security protocol that encodes or encrypts all network data before it is transmitted using a WEP key. Usually, you can allow the network to assign the WEP key. Alternatively, you can set up your own key, generate a different key, or choose other advanced options. Without the correct key, others will not be able to use the WLAN.
- **WPA (Wi-Fi Protected Access)**, like WEP, uses security settings to encrypt and decrypt data that is transmitted over the network. However, instead of using one static security key for encryptions as WEP does, WPA uses “temporal key integrity protocol” (TKIP) to dynamically generate a new key for every packet. It also generates different sets of keys for each device on the network.

Connecting to a WLAN

To connect to the WLAN, follow these steps:

1. Be sure that the WLAN device is on. If it is on, the wireless is white. If the wireless light is off, press the **f12** action key to turn on the wireless connection.
2. Click the network icon in the notification area, at the far right of the taskbar.
3. Select your WLAN from the list.
4. Click **Connect**.

If the network is a security-enabled WLAN, you are prompted to enter a network security key, which is a security code. Type the code, and then click **OK** to complete the connection.

 **NOTE:** If no WLANs are listed, you are out of range of a wireless router or access point.

NOTE: If you do not see the network you want to connect to, click **Open Network and Sharing Center**, and then click **Set up a new connection or network**. A list of options is displayed. You can choose to manually search for and connect to a network or to set up a new network connection.

After the connection is made, place the mouse pointer over the network icon in the notification area, at the far right of the taskbar, to verify the name and status of the connection.

 **NOTE:** The functional range (how far your wireless signals travel) depends on WLAN implementation, router manufacturer, and interference from other electronic devices or structural barriers such as walls and floors.

More information about using a WLAN is available through the following resources:

- Information from your ISP and the manufacturer's instructions included with your wireless router and other WLAN equipment
- Information and Web site links provided in Help and Support

For a list of public WLANs near you, contact your ISP or search the Web. Web sites that list public WLANs include Cisco Internet Mobile Office Wireless Locations, Hotspotlist, and Geektools. Check with each public WLAN location for cost and connection requirements.

For additional information on connecting your computer to a corporate WLAN, contact your network administrator or IT department.

Roaming to another network

When you move your computer within range of another WLAN, Windows attempts to connect to that network. If the attempt is successful, your computer is automatically connected to the new network. If Windows does not recognize the new network, follow the same procedure you used initially to connect to your WLAN.

Using HP Mobile Broadband (select models only)

HP Mobile Broadband enables your computer to use wireless wide area networks (WWANs) to access the Internet from more places and over larger areas than it can by using WLANs. Using HP Mobile Broadband requires a network service provider (called a *mobile network operator*), which in most cases is a mobile phone network operator. Coverage for HP Mobile Broadband is similar to mobile phone voice coverage.

When used with mobile network operator service, HP Mobile Broadband gives you the freedom to stay connected to the Internet, send e-mail, or connect to your corporate network whether you are on the road or outside the range of Wi-Fi hotspots.

The activation requirements for Code Division Multiple Access (CDMA) and Global System for Mobile Communications (GSM) are different as CDMA requires an MEID and GSM requires a SIM plus the SIM information.

HP Mobile Broadband supports the following technologies:

- HSPA (High Speed Packet Access), which provides access to networks based on the GSM telecommunications standard.

For HSPA service activation, you may need the HP Mobile Broadband Module International Mobile Equipment Identity (IMEI) number to activate mobile broadband service. The IMEI number is printed on a label inside the battery bay of your computer.

HSPA mobile network operators require the use of a subscriber identity module (SIM). A SIM contains basic information about you, such as a personal identification number (PIN), as well as network information.

Some computers include a SIM that is preinstalled in the battery bay. If the SIM is not preinstalled, it may be provided in the packet of HP Mobile Broadband information provided with your computer, or the mobile network operator may provide it separately from the computer.

For information on inserting and removing the SIM, refer to the “Inserting a SIM” and “Removing a SIM” sections in this chapter.

- EV-DO (Evolution Data Optimized), which provides access to networks based on the CDMA telecommunications standard.

You may need the HP Mobile Broadband Module Mobile Equipment Identifier (MEID) to activate mobile broadband service. The MEID is printed on a label inside the battery bay of your computer.

For information on HP Mobile Broadband and how to activate service with a preferred mobile network operator, refer to the HP Mobile Broadband information included with your computer. For additional information, see the HP Web site at <http://www.hp.com/go/mobilebroadband> (U.S. only).

Inserting a SIM

- △ **CAUTION:** When inserting a SIM, position the card with the slanted corner as shown in the illustration. If a SIM is inserted backwards or upside down, the battery may not snap into place properly and could damage the SIM and the SIM connector.

To prevent damage to the connectors, use minimal force when inserting a SIM.

To insert a SIM:

1. Shut down the computer. If you are not sure whether the computer is off or in Hibernation, turn the computer on by sliding the power switch. Then shut down the computer through the operating system.
2. Close the display.
3. Disconnect all external devices connected to the computer.
4. Unplug the power cord from the AC outlet.
5. Turn the computer upside down on a flat surface, with the battery bay toward you.
6. Remove the battery.

 **NOTE:** For more information, refer to the section “Inserting and removing the battery,” earlier in this guide.

7. Insert the SIM into the SIM slot, and gently push the SIM into the slot until it is firmly seated.

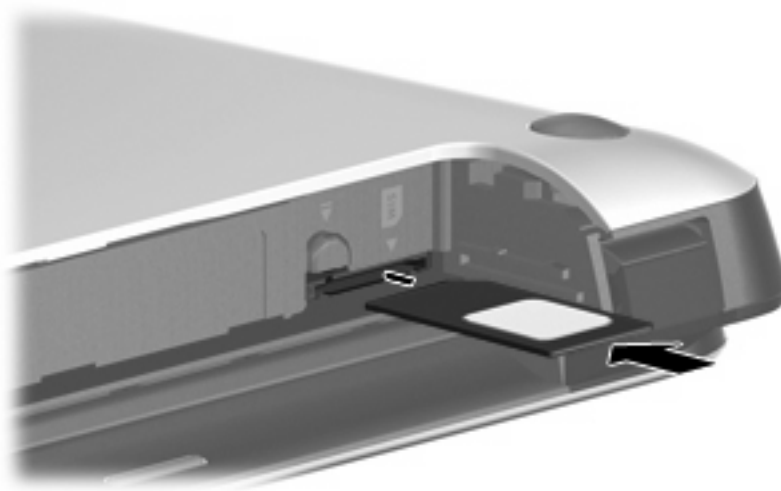

8. Replace the battery.

 **NOTE:** If the battery is not replaced, HP Mobile Broadband is disabled.

9. Reconnect external power.
10. Reconnect external devices.
11. Turn on the computer.

Removing a SIM

To remove a SIM:

1. Shut down the computer. If you are not sure whether the computer is off or in Hibernation, turn the computer on by sliding the power switch. Then shut down the computer through the operating system.
2. Close the display.

3. Disconnect all external devices connected to the computer.
4. Unplug the power cord from the AC outlet.
5. Turn the computer upside down on a flat surface, with the battery bay toward you.
6. Remove the battery.
7. Press in on the SIM, and then remove it from the slot.

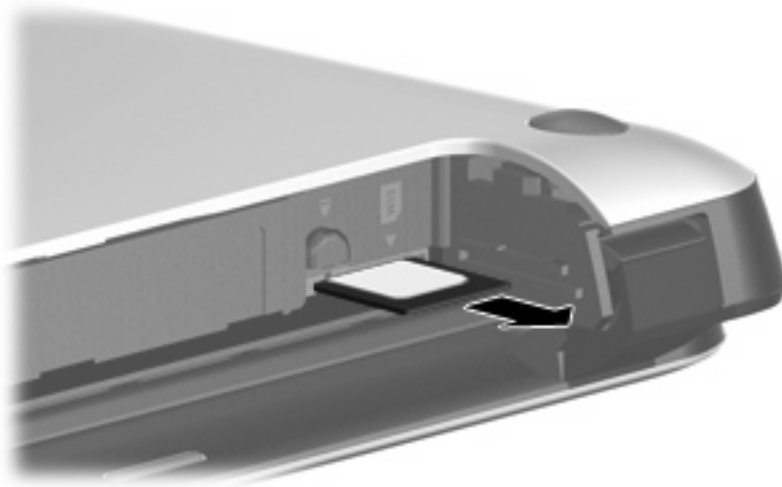

8. Replace the battery and the back cover.
9. Reconnect external power.
10. Reconnect external devices.
11. Turn on the computer.

Using Bluetooth wireless devices

A Bluetooth device provides short-range wireless communications that replace the physical cable connections that traditionally link electronic devices such as the following:

- Computers (desktop, notebook, PDA)
- Phones (cellular, smart phone)
- Imaging devices (printer, camera)
- Audio devices (headset, speakers)

Bluetooth devices provide peer-to-peer capability that allows you to set up a personal area network (PAN) of Bluetooth devices. For information on configuring and using Bluetooth devices, refer to the Bluetooth software Help.

Bluetooth and Internet Connection Sharing (ICS)

HP does **not** recommend setting up one computer with Bluetooth as a host and using it as a gateway through which other computers may connect to the Internet. When two or more computers are connected using Bluetooth, and Internet Connection Sharing (ICS) is enabled on one of the computers, the other computers may not be able to connect to the Internet using the Bluetooth network.

The strength of Bluetooth is in synchronizing information transfers between your Mini and wireless devices including cellular phones, printers, cameras, and PDAs. The inability to consistently connect two or more computers to share the Internet through Bluetooth is a limitation of Bluetooth and the Windows operating system.

5 Multimedia

Multimedia features

Your computer includes multimedia features that allow you to listen to music, watch movies, and view pictures. Your computer may include the following multimedia components:



- Integrated speakers for listening to music
- Integrated webcam that allows you to capture photographs and videos
- Preinstalled multimedia software that allows you to play and manage your music, movies, and pictures



The following sections explain how to identify and use the multimedia components included with your computer.

Identifying your multimedia components

The following illustration and table describe the multimedia features of the computer.



Component	Description
(1) Webcam light	On: The webcam is in use.
(2) Webcam	Records video and captures still photographs. NOTE: To capture and edit videos, you can use the preinstalled Arcsoft WebCam Companion 3 software
(3) Internal microphone	Records sound.
(4) Speakers (2)	Produce sound.
(5)  Volume mute action key (f11)	Mutes or restores speaker sound.
(6)  Volume up action key (f10)	Increases speaker volume.

Component	Description
(7)  Volume down action key (f9)	Decreases speaker volume.
(8)  Audio-out (headphone) jack/Audio-in (microphone) jack	Produces sound when connected to optional powered stereo speakers, headphones, earbuds, a headset, or television audio. Also connects an optional headset microphone. WARNING! To reduce the risk of personal injury, adjust the volume before putting on headphones, earbuds, or a headset. For additional safety information, refer to the <i>Regulatory, Safety and Environmental Notices</i> . NOTE: When a device is connected to the jack, the computer speakers are disabled. The audio component must have a 4-conductor connector.

Adjusting the volume

You can adjust the volume using the following computer volume action keys:

- To decrease volume, press the volume down action key (f9) (1).
- To increase volume, press the volume up action key (f10) (2).
- To mute or restore volume, press the volume mute action key (f11) (3).

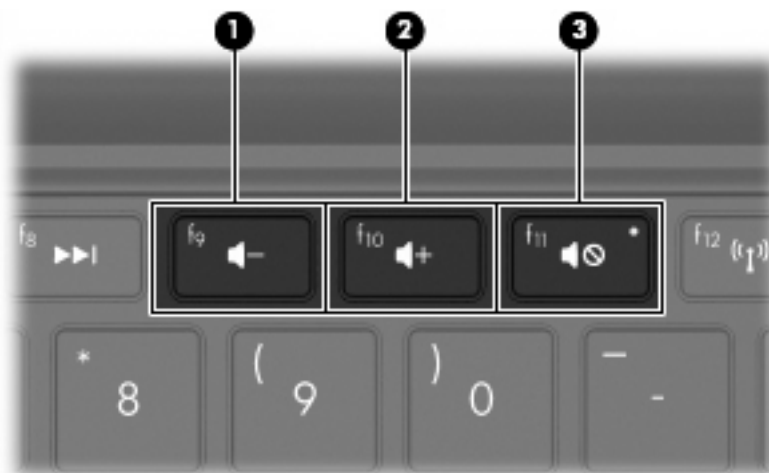

- Windows® volume control:
 - Click the **Speakers** icon in the notification area, at the far right of the taskbar.
 - Increase or decrease the volume by moving the slider up or down. Click the **Mute Speakers** icon to mute the volume.

– or –

 - Right-click the **Speakers** icon in the notification area, and then click **Open Volume Mixer**.
 - In the Speakers column, increase or decrease the volume by moving the slider up or down. You can also mute the volume by clicking the **Mute Speakers** icon.

If the Speakers icon is not displayed in the notification area, follow these steps to add it:

- a. Right-click the **Show hidden icons** icon (the arrow at far left of the notification area).
 - b. Click **Customize notification icons**.
 - c. Under **Behaviors**, select **Show icon and notifications** for the Speakers icon.
 - d. Click **OK**.
- Program volume control:

Volume can also be adjusted within some programs.

Using the media activity action keys

The media activity action keys control the play of an audio CD or a DVD or BD that is inserted into an external optical drive (purchased separately).

 **NOTE:** The external optical drive must be connected to a USB port *on the computer*, not to a USB port on another external device, such as a hub.

- When an audio CD or a DVD or BD is not playing, press the **play/pause** action key (f6) (2) to play the disc.
- When an audio CD or a DVD or BD is playing, use the following keys:
 - To play the previous track of an audio CD or the previous chapter of a DVD or BD, press the **previous track** action key (f5) (1).
 - To pause or resume playing the disc, press the **play/pause** action key (f6) (2).
 - To stop the disc, press the **stop** action key (f7) (3).
 - To play the next track of an audio CD or the next chapter of a DVD or BD, press the **next track** action key (f8) (4).

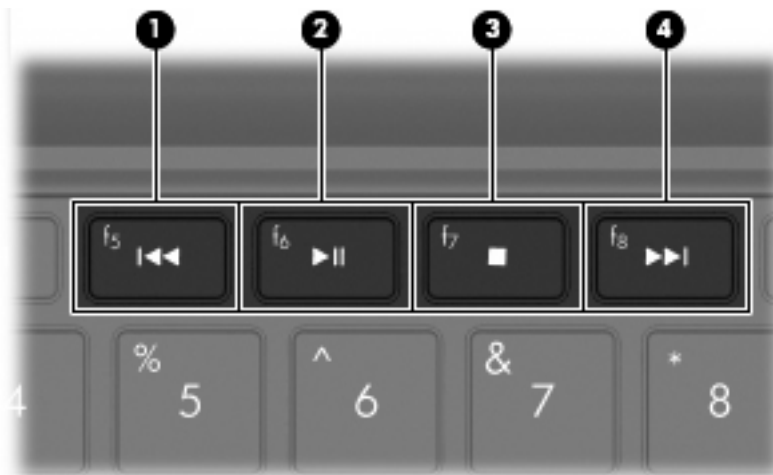

Multimedia software

Your computer includes preinstalled multimedia software. Depending on the hardware and software included with the computer, the following multimedia tasks may be supported:

- Playing digital media, including audio and video CDs, audio and video DVDs, and Internet radio
- Creating or copying data CDs
- Creating, editing, and burning audio CDs
- Creating, editing, and burning a video or movie to a DVD or video CD

Using preinstalled multimedia software

To locate preinstalled multimedia software:

- ▲ Select **Start > All Programs**, and then open the multimedia program you want to use. For example, if you want to use Windows Media Player (select models only), click **Windows Media Player**.

 **NOTE:** Some programs may be located in subfolders.

Installing multimedia software from the Internet

- ▲ To install multimedia software from the Internet, go to the software manufacturer's Web site and follow the instructions.

 **NOTE:** Software downloaded from the Internet may contain viruses. Refer to the "Security" chapter for more information.

Audio

Your computer has a variety of audio features that allow you to:

- Play music using your computer speakers and/or connected external speakers.
- Record sound using the internal microphone or an optional external headset microphone.
- Download music from the Internet.
- Create multimedia presentations using audio and images.
- Transmit sound and images with instant messaging programs.

Connecting external audio devices

 **WARNING!** To reduce the risk of personal injury, adjust the volume before putting on headphones, earbuds, or a headset. For additional safety information, refer to the *Regulatory, Safety and Environmental Notices*.

To connect external devices such as external speakers, headphones, or a headset microphone, refer to the information provided with the device. For best results, remember the following tips:

- Be sure that the device cable has a 4-conductor connector that supports both audio-out (headphone) and audio-in (microphone).
- Be sure that the external device cable is securely connected to the jack on your computer.
- Be sure to install any drivers required by the external device.

 **NOTE:** A driver is a required program that acts like a translator between the device and the programs that use the device.

Checking your audio functions

To check the system sound on your computer, follow these steps:

1. Select **Start > Control Panel**.
2. Click **Hardware and Sound**.
3. Click **Sound**.
4. When the Sound window opens, click the **Sounds** tab. Under **Program Events**, select any sound event, such as a beep or alarm, and click the **Test** button.

You should hear sound through the speakers or through connected headphones.

To check the record functions of the computer, follow these steps:

1. Select **Start > All Programs > Accessories > Sound Recorder**.
2. Click **Start Recording** and speak into the microphone. Save the file to your desktop.
3. Open Windows Media Player or TouchSmart and play back the sound.

 **NOTE:** For best results when recording, speak directly into the microphone and record sound in a setting free of background noise.

To confirm or change the audio settings on your computer, select **Start > Control Panel > Hardware and Sound > Sound**.

Video

Your computer enables you to use a variety of video features:

- Watch movies
- Play games over the Internet
- Edit pictures and video to create presentations
- Connect external video devices

Connecting an external monitor or projector

Use a VGA cable (purchased separately) to connect an external display, such as a monitor or projector, to the external monitor port on the computer.

To connect an external monitor or projector:

1. Connect the optional VGA cable to the external monitor port on the computer.

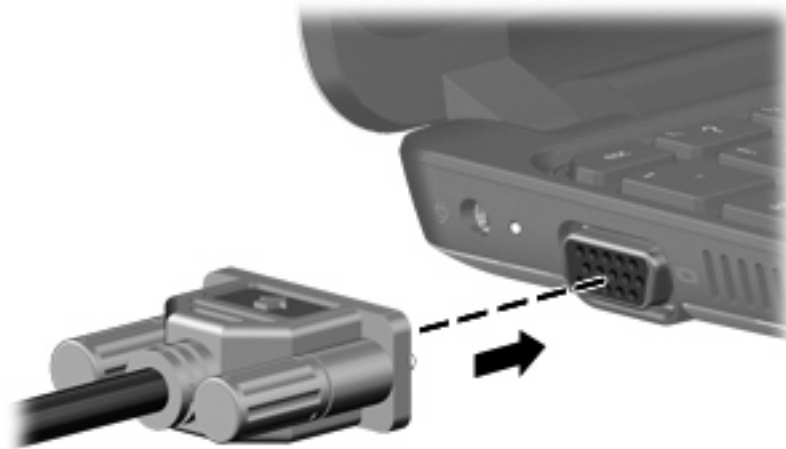

2. Connect the external monitor or projector to the other end of the cable.

NOTE: If a properly connected external monitor or projector does not display a screen image, press the **f4** action key to transfer the image to the external display. Repeatedly pressing **f4** alternates the screen image between the external display and the computer.

Webcam

Your computer includes an integrated webcam, located at the top of the display. The webcam is an input device that allows you to record video and capture still photographs.

 **NOTE:** To record and edit videos, you can use the preinstalled Arcsoft WebCam Companion 3

To access the webcam using Arcsoft WebCam Companion 3 software:

1. Select **Start > All Programs > Arcsoft WebCam Companion 3**.
2. You may choose **Capture** or **Edit** from the dialog box.

 **NOTE:** For more information, refer to Arcsoft WebCam Companion 3 software Help.

6 Security

Protecting the computer

Standard security features provided by the Windows operating system and the non-Windows Setup Utility can protect your personal settings and data from a variety of risks.

Follow the procedures in this chapter to use the following features:

- Passwords
- Firewall software
- Antivirus support (Norton Internet Security)
- Critical security updates

 **NOTE:** Security solutions are designed to act as deterrents, but they may not deter software attacks or prevent the computer from being mishandled or stolen.

NOTE: Before you send your computer for service, remove all password settings.

Computer risk	Security feature
Unauthorized use of the computer	Power-on password
Unauthorized access to data	<ul style="list-style-type: none">• Firewall software• Windows updates
Unauthorized access to Setup Utility, BIOS settings, and other system identification information	Administrator password
Ongoing or future threats to the computer	Critical security updates from Microsoft
Unauthorized access to a Windows user account	User password

Using passwords

A password is a group of characters that you choose to secure your computer information. Several types of passwords can be set, depending on how you want to control access to your information. Passwords can be set in Windows or in the non-Windows Setup Utility preinstalled on the computer.

 **CAUTION:** To prevent being locked out of the computer, record each password you set. Because most passwords are not displayed as they are set, changed, or deleted, it is essential to record each password immediately and store it in a secure place.

You can use the same password for a Setup Utility feature and for a Windows security feature. You can also use the same password for more than one Setup Utility feature.

Use the following guidelines when setting a password in Setup Utility:

- A password can be any combination of up to 8 letters and numbers and is case sensitive.
- A password set in Setup Utility must be entered at a Setup Utility prompt. A password set in Windows must be entered at a Windows prompt.

Use the following tips for creating and saving passwords:

- When creating passwords, follow requirements set by the program.
- Write down your passwords and store them in a secure place away from the computer.
- Do not store passwords in a file on the computer.
- Do not use your name or other personal information that could be easily discovered by an outsider.

The following sections list Windows and Setup Utility passwords and describe their functions. For additional information about Windows passwords, such as screen-saver passwords, select **Start > Help and Support**.

Setting passwords in Windows

Password	Function
Administrator password	Protects administrator-level access to computer contents. NOTE: This password cannot be used to access Setup Utility contents.
User password	Protects access to a Windows user account. It also protects access to the computer contents and must be entered when you exit Sleep or Hibernation.

Setting passwords in Setup Utility

Password	Function
Administrator password*	<ul style="list-style-type: none">• Protects access to Setup Utility.• After this password is set, it must be entered each time you access Setup Utility. CAUTION: If you forget your administrator password, you cannot access Setup Utility.
Power-on password*	<ul style="list-style-type: none">• Protects access to the computer contents.• After this password is set, it must be entered each time you turn on or restart the computer, or exit Hibernation. CAUTION: If you forget your power-on password, you cannot turn on or restart the computer, or exit Hibernation.

*For details about each of these passwords, refer to the following topics.

Administrator password

Your administrator password protects the configuration settings and system identification information in Setup Utility. After this password is set, you must enter it each time you access Setup Utility.

Your administrator password is not interchangeable with an administrator password set in Windows, nor is it displayed as it is set, entered, changed, or deleted. Be sure that you record your password and store it in a safe place.

Managing an administrator password

To set, change, or delete this password, follow these steps:

1. Open Setup Utility by turning on or restarting the computer, and then pressing **F10** while the “F10 = BIOS Setup Options” message is displayed in the lower-left corner of the screen.
2. Use the arrow keys to select **Security > Set Administrator Password**, and then press **enter**.
 - To set an administrator password, type your password in the **Enter New Password** and **Confirm New Password** fields, and then press **enter**.
 - To change an administrator password, type your current password in the **Enter Current Password** field, type a new password in the **Enter New Password** and **Confirm New Password** fields, and then press **enter**.
 - To delete an administrator password, type your current password in the **Enter Password** field, and then press **enter** 4 times.
3. To save your changes and exit Setup Utility, use the arrow keys to select **Exit > Exit Saving Changes**.

Your changes go into effect when the computer restarts.

Entering an administrator password

At the **Enter Password** prompt, type your administrator password, and then press **enter**. After 3 unsuccessful attempts to enter the administrator password, you must restart the computer and try again.

Power-on password

Your power-on password prevents unauthorized use of the computer. After this password is set, it must be entered each time you turn on or restart the computer, or exit Hibernation. A power-on password is not displayed as it is set, entered, changed, or deleted.

Managing a power-on password

To set, change, or delete this password, follow these steps:

1. Open Setup Utility by turning on or restarting the computer, and then pressing **f10** while the “F10 = BIOS Setup Options” message is displayed in the lower-left corner of the screen.
2. Use the arrow keys to select **Security > Set Power-On Password**, and then press **enter**.
 - To set a power-on password, type your password in the **Enter New Password** and **Confirm New Password** fields, and then press **enter**.
 - To change a power-on password, type your current password in the **Enter Current Password** field, type a new password in the **Enter New Password** and **Confirm New Password** fields, and then press **enter**.
 - To delete a power-on password, type your current password in the **Enter Current Password** field, and then press **enter** 4 times.
3. To save your changes and exit Setup Utility, use the arrow keys to select **Exit > Exit Saving Changes**.

Your changes go into effect when the computer restarts.

Entering a power-on password

At the **Enter Password** prompt, type your password, and then press **enter**. After 3 unsuccessful attempts to enter the password, you must restart the computer and try again.

Using antivirus software

When you use the computer for e-mail or Internet access, you expose it to computer viruses that can disable the operating system, programs, or utilities or cause them to function abnormally.

Antivirus software can detect most viruses, destroy them, and in most cases, repair damage they have caused. To provide ongoing protection against newly discovered viruses, antivirus software must be kept up to date.

Norton Internet Security, an antivirus program, is preinstalled on the computer.

- Your version of Norton Internet Security includes 60 days of free updates. It is strongly recommended that you protect the computer against new viruses beyond 60 days by purchasing extended update service. Instructions for using and updating Norton Internet Security software and for purchasing extended update service are provided within the program.
- To access Norton Internet Security, or to get more information about it, select **Start > All Programs > Norton Internet Security**.

 **NOTE:** HP recommends that you always update the antivirus software to help protect your computer.

NOTE: For more information about computer viruses, type `viruses` in the Search box in Help and Support.

Using firewall software

When you use the computer for e-mail, network, or Internet access, unauthorized persons may be able to gain access to the computer, your personal files, and information about you. Use the firewall software preinstalled on the computer to protect your privacy.

Firewall features include logging and reporting of network activity, and automatic monitoring of all incoming and outgoing traffic. Refer to the firewall user guide or contact your firewall manufacturer for more information.

 **NOTE:** Under some circumstances a firewall can block access to Internet games, interfere with printer or file sharing on a network, or block authorized e-mail attachments. To temporarily resolve the problem, disable the firewall, perform the task that you want to perform, and then reenable the firewall. To permanently resolve the problem, reconfigure the firewall.

Installing critical updates

△ **CAUTION:** Microsoft sends alerts regarding critical updates. To protect the computer from security breaches and computer viruses, install all critical updates from Microsoft as soon as you receive an alert.

Updates to the operating system and other software may have become available after the computer was shipped. To be sure that all available updates are installed on the computer, observe these guidelines:

- Run Windows Update as soon as possible after you set up your computer. Use the update link at **Start > All Programs > Windows Update**.
- Run Windows Update at regular intervals, such as once a month.
- Obtain updates to Windows and other Microsoft programs, as they are released, from the Microsoft Web site and through the updates link in Help and Support.

7 Digital cards

Optional digital cards provide secure data storage and convenient data sharing. These cards are often used with digital media–equipped cameras and PDAs as well as with other devices.

The Digital Media Slot supports the following formats:

- Memory Stick (MS)
- MS/Pro
- MultiMediaCard (MMC)
- Secure Digital High Capacity (SDHC) Memory Card (standard and large size)
- xD-Picture card

Inserting a digital card

△ **CAUTION:** To avoid damaging the digital card or the computer, do not insert any type of adapter into the Digital Media Slot.

CAUTION: To prevent damage to the digital card connectors, use minimal force to insert a digital card.

1. Hold the digital card label-side up, with the connectors toward the computer.
2. Insert the card into the Digital Media Slot, and then push in on the card until it is firmly seated.

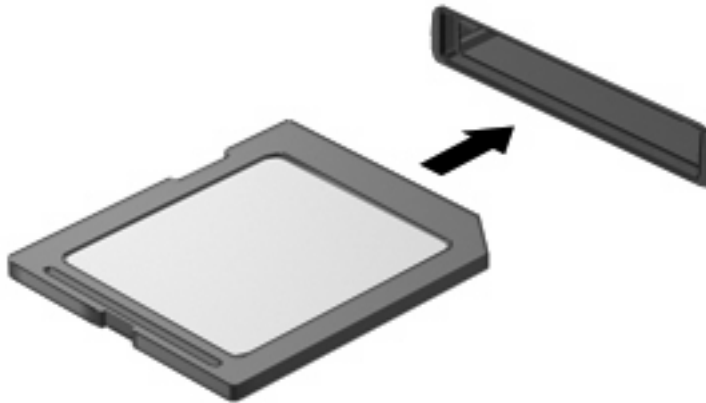

You will hear a sound when the device has been detected, and a menu of options may be displayed.

Removing a digital card

△ **CAUTION:** To prevent loss of information or an unresponsive system, use the following procedure to safely remove the digital card.

1. Save your information and close all programs associated with the digital card.

📝 **NOTE:** To stop a data transfer, click **Cancel** in the operating system Copying window.

2. To remove a digital card:

- a. Click the **Safely Remove Hardware and Eject Media** icon in the notification area, at the far right of the taskbar.

📝 **NOTE:** To display the Safely Remove Hardware and Eject Media icon, click the **Show hidden icons** icon (the arrow at the left side of the notification area).

- b. Click the name of the digital card in the list.

📝 **NOTE:** You are prompted that it is safe to remove the hardware device.

- c. Press in on the digital card and then remove the digital card from the slot.

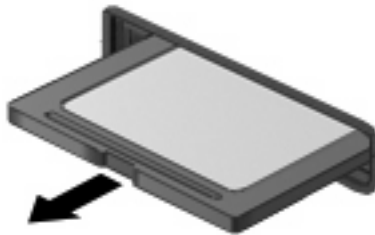

8 USB devices

Using a USB device

Universal Serial Bus (USB) is a hardware interface that can be used to connect an optional external device, such as a USB keyboard, mouse, drive, printer, scanner, or hub. Devices can be connected to the system.

Some USB devices may require additional support software, which is usually included with the device. For more information about device-specific software, refer to the manufacturer's instructions.

The computer has 3 USB ports, which support USB 1.0, USB 1.1, and USB 2.0 devices. An optional USB hub provides additional USB ports that can be used with the computer.

Connecting a USB device

△ **CAUTION:** To prevent damage to a USB connector, use minimal force to connect a USB device.

▲ To connect a USB device, connect the USB cable for the computer to the USB port.



You will hear a sound when the device has been detected.

📝 **NOTE:** When you connect a USB device, you may see a message in the notification area to let you know that the device is recognized by the system.

Removing a USB device

△ **CAUTION:** To prevent loss of information or an unresponsive system, use the following procedure to safely remove a USB device.

CAUTION: To prevent damage to a USB connector, do not pull on the cable to remove the USB device.

To remove a USB device:

1. Click the **Safely Remove Hardware and Eject Media** icon in the notification area, at the far right of the taskbar.

 **NOTE:** To display the Safely Remove Hardware and Eject Media icon, click the **Show hidden icons** icon (the arrow at the left of the notification area).

2. Click the name of the device in the list.

 **NOTE:** You are informed that it is safe to remove the device.

3. Remove the device.

9 Pointing devices and keyboard

Setting pointing device preferences

Use Mouse Properties in Windows® to customize settings for pointing devices, such as button configuration, click speed, and pointer options.

To access Mouse Properties, select **Start > Devices and Printers**. Then, right-click the device representing your device, and select **Mouse settings**.

Using the TouchPad

To move the pointer, slide your finger across the TouchPad surface in the direction you want the pointer to go. Use the TouchPad buttons like the corresponding buttons on an external mouse. To scroll up and down using the TouchPad vertical scroll zone, slide your finger up or down over the lines.

 **NOTE:** For more information on identifying the TouchPad components, refer to the “Touchpad” section earlier in this guide

The TouchPad supports a variety of TouchPad gestures. To activate the TouchPad gestures, place two fingers on the TouchPad as described in the following sections.

The TouchPad gestures described in this section are enabled at the factory. To disable or reenoble these gestures:

1. Double-click the **Synaptics** icon in the notification area, at the far right of the taskbar, and then click the **Device Settings** tab
2. Select the device, and then click **Settings**
3. Select the check box to disable or reenoble the TouchPad gesture.
4. Click **Apply** and then click **OK**.

Scrolling

Scrolling is useful for moving up or down on a page or image. To scroll, place two fingers on the TouchPad and drag them across the TouchPad in an up, down, left, or right motion.

 **NOTE:** Scrolling speed is controlled by finger speed.

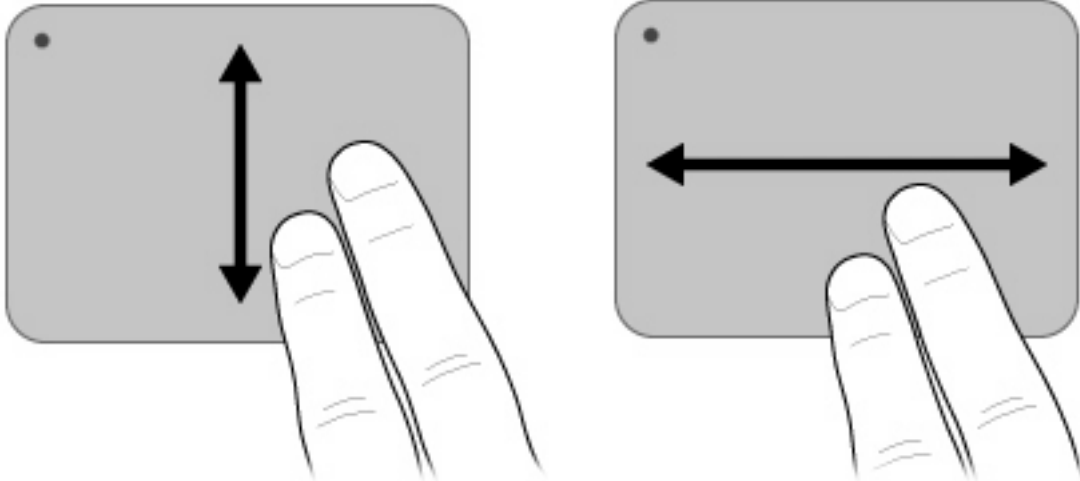

Pinching

Pinching allows you to zoom in or out on items such as PDFs, images, and photos.

To pinch:

- Zoom in by holding two fingers together on the TouchPad, and then pull the fingers apart to increase an object's size.
- Zoom out by holding two fingers apart on the TouchPad, and then pull the fingers together to decrease an object's size.

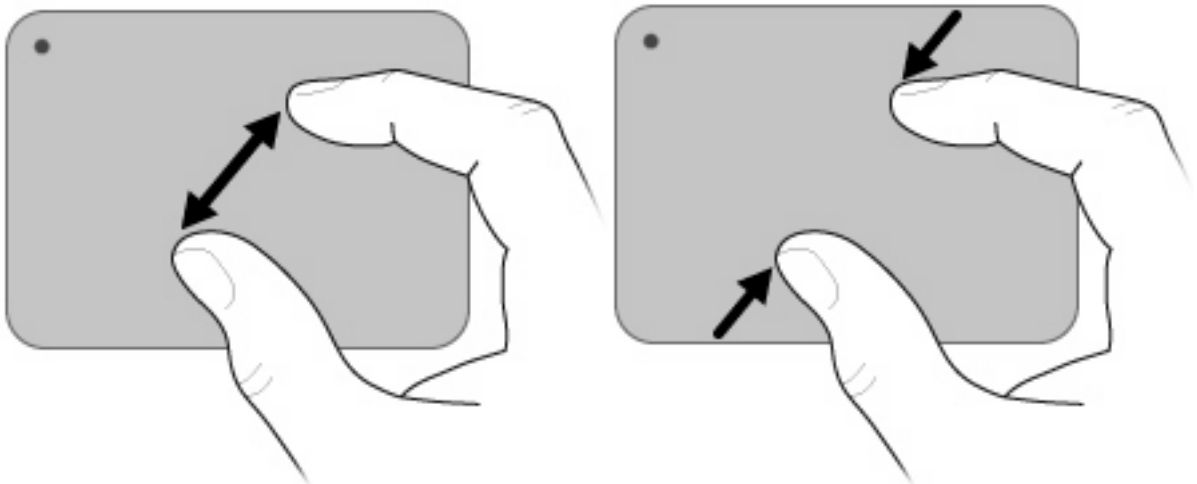

Rotating

Rotating allows you rotate items such as photos and pages. To rotate, anchor your thumb on the TouchPad, and then move your forefinger in a semicircular motion around your thumb.

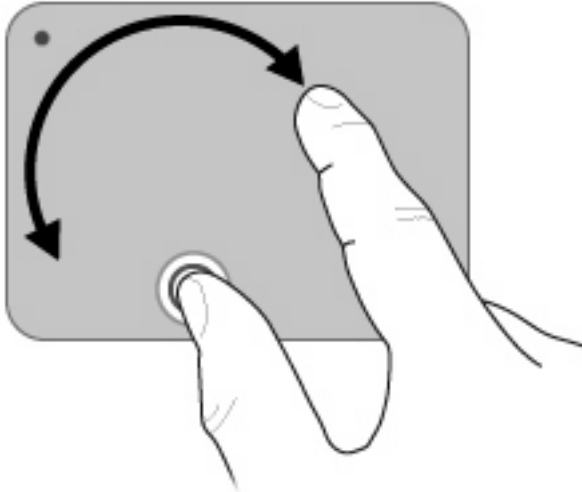

Connecting an external mouse

You can connect an external USB mouse to the computer using one of the USB ports on the computer.

Using the keyboard

Using the action keys



Action keys are customized actions that are assigned to specific keys at the top of the keyboard.











To use an action key, press and hold this key to activate the assigned function.

 **NOTE:** Depending on the program you are using, pressing **fn** and one of the action keys opens a specific shortcut menu within that program.

NOTE: The action key feature is enabled at the factory. You can disable this feature in Setup Utility to require pressing the **fn** key and one of the action keys to activate the assigned function. Refer to the “Setup Utility” chapter for additional information.



Icon	Description
	Opens Help and Support, which provides information about your Windows operating system and computer, answers to questions and tutorials, and updates to your computer. Help and Support also provides automated troubleshooting and links to support specialists.
	Decreases the screen brightness level incrementally when you hold down this key.

Icon	Description
	Increases the screen brightness level incrementally when you hold down this key.
	<p>Switches the screen image among display devices connected to the system. For example, if a monitor is connected to the computer, pressing this key alternates the screen image from computer display to monitor display to simultaneous display on both the computer and the monitor.</p> <p>Most external monitors receive video information from the computer using the external VGA video standard. The switch screen image key can also alternate images among other devices that are receiving video information from the computer.</p>
	Plays the previous track of a CD or the previous section of a DVD or a BD.
	Plays a track of an audio CD or a section of a DVD or a BD.
	Stops audio playback of a CD, a DVD, or a BD.
	Plays the next track of an audio CD or the next section of a DVD or a BD.
	Decreases speaker volume incrementally when you hold down this key.
	Increases speaker volume incrementally when you hold down this key.
	Mutes or restores speaker sound.
	<p>Turns the wireless feature on or off.</p> <p>NOTE: This key does not establish a wireless connection. To establish a wireless connection, a wireless network must also be set up.</p>
<code>prt sc</code>	Takes a snapshot or picture of your computer screen and copies it to the clipboard.

Using hotkeys

Hotkeys are combinations of the `fn` key **(1)** and the `esc` key **(2)**.

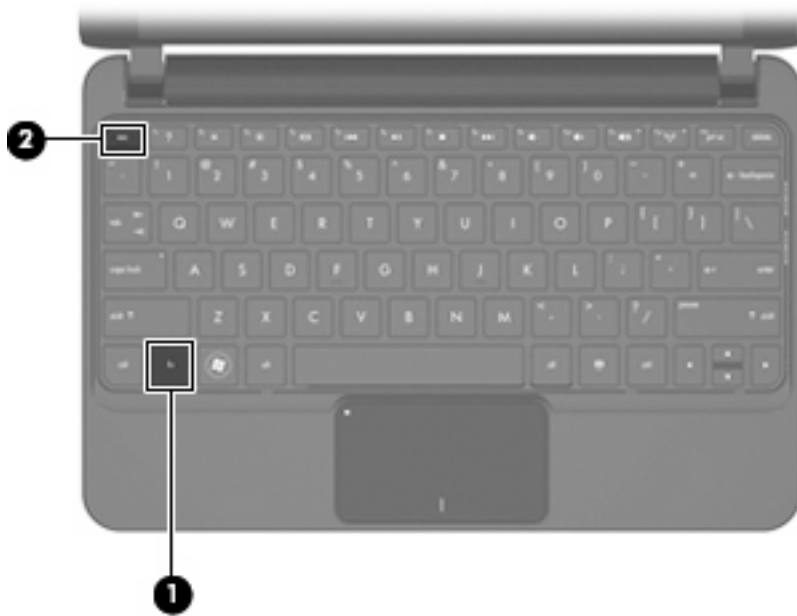

Function	Hotkey	Description
Display system information.	<code>fn+esc</code>	Displays information about system hardware components and the system BIOS version number.

To use a hotkey command on the computer keyboard, follow either of these steps:

- Briefly press the `fn` key, and then briefly press the second key of the hotkey command.
– or –
- Press and hold down the `fn` key, briefly press the second key of the hotkey command, and then release both keys at the same time.

Using the touch screen (select models only)

Some computer models allow you to use your fingers to perform certain actions on the touch screen.

 **NOTE:** The instructions in this section are based on the preferences set at the factory. To modify settings for recognized clicks and flicks, select **Start > Control Panel > Hardware and Sound > Pen and Touch**.

Tapping (or clicking)

Tap or double-tap an item on the screen as you would click or double-click with the TouchPad or an external mouse. Tap and hold an item to see the context menu as you would with the right TouchPad button.

 **NOTE:** You must tap and hold your finger until the operating system draws a circle around the area you are touching, and then the context menu appears.

Flicking

Touch the screen in a light, quick flicking motion up, down, left, or right to navigate through screens or quickly scroll through documents.

 **NOTE:** For the flick movement to work, a scrollbar must be present and in the active window.

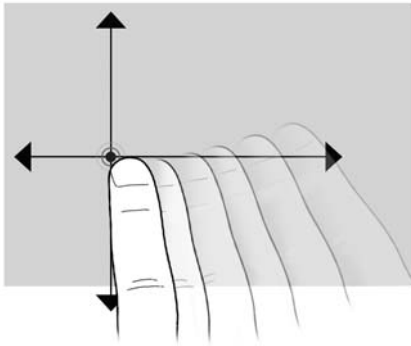

Dragging

Press your finger on an item on the screen, and then move your finger to drag the item to a new location. You can also use this motion to slowly scroll through documents.

Scrolling

Scrolling is useful for moving up or down on a page or image. To scroll, place two fingers on the screen, and then drag them across the screen in an up, down, left, or right motion.

 **NOTE:** Scrolling speed is controlled by finger speed.

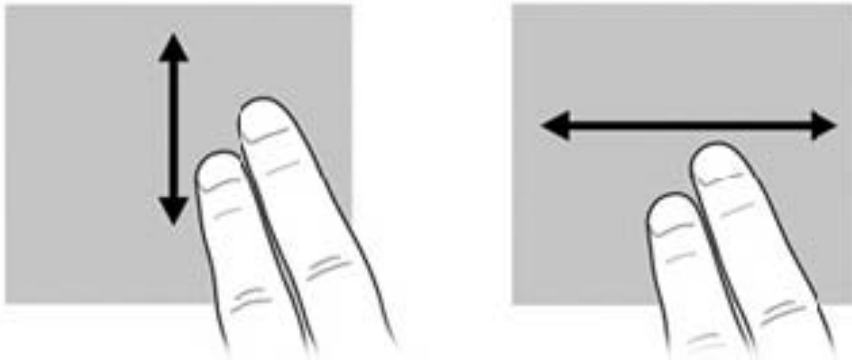

Rotating

Rotating allows you rotate items such as photos and pages. To rotate, anchor your thumb on the screen, and then move your forefinger in a semicircular motion around your thumb.

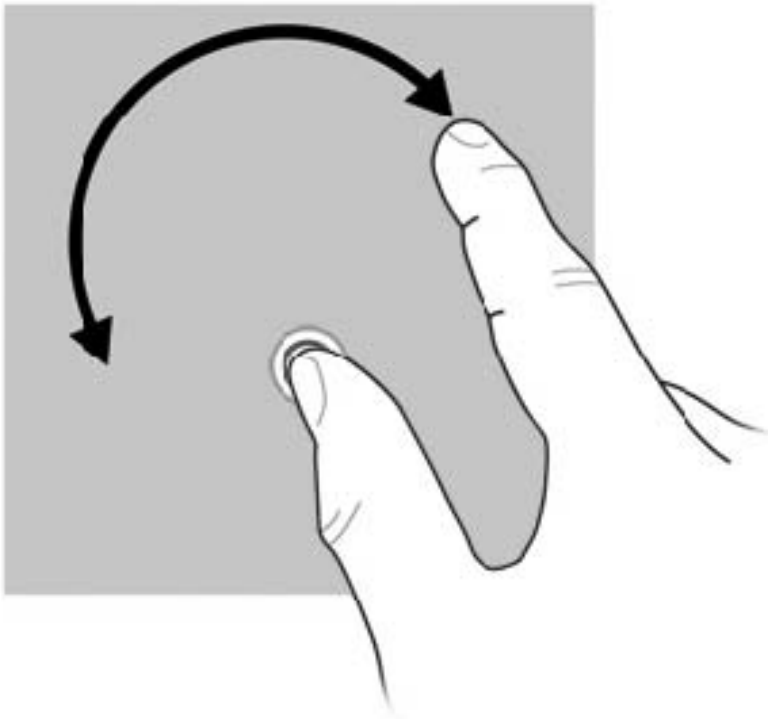

Pinching

Pinching allows you to zoom in or out on items such as PDFs, images, and photos.

To pinch:

- Zoom out by holding two fingers apart on the screen, and then pull the fingers together to decrease an object's size.
- Zoom in by holding two fingers together on the screen, and then pull the fingers apart to increase an object's size.

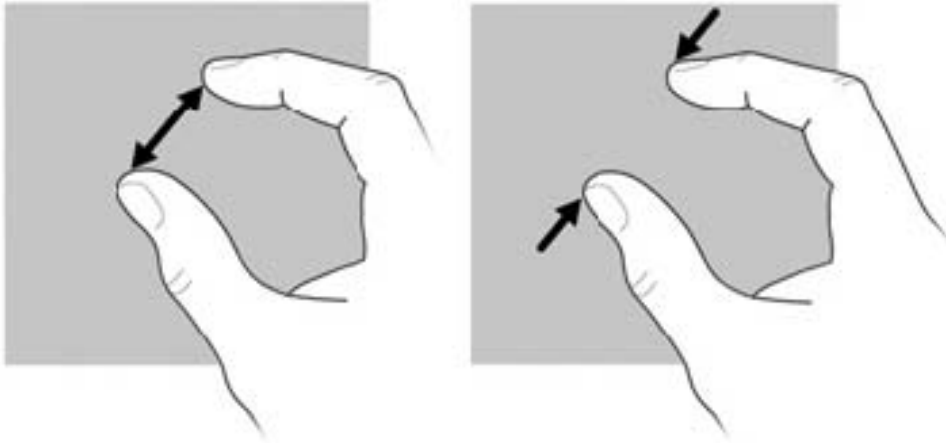

Setting touch screen preferences

- ▲ To set preferences for visual feedback, select **Start > Control Panel > Hardware and Sound > Pen and Touch**. These preferences are specific to the touch screen and the computer.
- ▲ To set preferences for left-handed or right-handed users, select **Start > Control Panel > Hardware and Sound > Tablet PC Settings > Other** tab. These preferences are specific to the touch screen and the computer.
- ▲ To set pointing device preferences such as pointer speed, click speed, and mouse trails, select **Start > Devices and Printers**. Then, right-click the device representing your computer, and select **Mouse settings**. These preferences apply to any pointing device in the system.

To change or test click settings:

1. Select **Start > Control Panel > Hardware and Sound > Pen and Touch > Pen Options** tab.
2. Under **Pen Actions**, select the action, and then click **Settings**.
3. After making any changes or testing the settings, click **OK**.

To change or create flick assignments:

1. Select **Start > Control Panel > Hardware and Sound > Pen and Touch > Flicks** tab.
2. Click **Navigational flicks and editing flicks** and then click **Customize**.
3. Follow the on-screen instructions to change or create a flick assignment.
4. Click **OK**.

10 Drives

Identifying installed drives

To view the drives installed on the computer, select **Start > Computer**.

Handling drives

Drives are fragile computer components that must be handled with care. Refer to the following cautions before handling drives. Additional cautions are included with the procedures to which they apply.

△ **CAUTION:** To reduce the risk of damage to the computer, damage to a drive, or loss of information, observe these precautions:

Before you move a computer that is connected to an external hard drive, initiate Sleep and allow the screen to clear, or properly disconnect the external hard drive.

Before handling a drive, discharge static electricity by touching the unpainted metal surface of the drive.

Do not touch the connector pins on a removable drive or on the computer.

Handle a drive carefully; do not drop a drive or place items on it.

Before removing or inserting a drive, shut down the computer. If you are unsure whether the computer is off, in the Sleep state, or in Hibernation, turn the computer on and then shut it down through the operating system.

Do not use excessive force when inserting a drive into a drive bay.

Do not type on the keyboard or move the computer while an optional optical drive is writing to a disc. The write process is sensitive to vibration. The external optical drive must be connected to a USB port *on the computer*, not to a USB port on another external device, such as a hub.

When the battery is the only source of power, be sure that the battery is sufficiently charged before writing to media.

Avoid exposing a drive to temperature or humidity extremes.

Avoid exposing a drive to liquids. Do not spray the drive with cleaning products.

Remove media from a drive before removing the drive from the drive bay, or traveling with, shipping, or storing a drive.

If a drive must be mailed, place the drive in a bubble-pack mailer or other suitable protective packaging and label the package “FRAGILE.”

Avoid exposing a drive to magnetic fields. Security devices with magnetic fields include airport walk-through devices and security wands. The airport security devices that check carry-on luggage, such as conveyor belts, use X-rays instead of magnetism and will not damage a drive.

Using external drives

Removable external drives expand your options for storing and accessing information.

USB drives include the following types:

- 1.44-megabyte diskette drive
- Hard drive module (a hard drive with an adapter attached)
- DVD-ROM Drive
- DVD/CD-RW Combo Drive
- DVD+RW/R and CD-RW Combo Drive
- DVD±RW/R and CD-RW Combo Drive

Using optional external devices

 **NOTE:** For more information about required software and drivers, or to learn which device port to use, refer to the manufacturer's instructions.

To connect an external device:

 **CAUTION:** To reduce the risk of damage to the equipment when connecting a powered device, be sure that the computer is turned off and the AC power cord is unplugged.

1. Connect the device.
2. If you are connecting a powered device, plug the device power cord into a grounded AC outlet.
3. Turn on the computer.

To disconnect an unpowered external device, turn off the computer, and then disconnect it. To disconnect a powered external device, turn off the computer, disconnect it, and then unplug the AC power cord.

11 Memory modules

The computer has one memory module compartment, which is located on the bottom of the computer, beneath the removable bottom panel. The memory capacity of the computer can be upgraded by replacing the existing memory module in the memory module slot.

- △ **WARNING!** To reduce the risk of electric shock and damage to the equipment, unplug the power cord and remove all batteries before installing a memory module.
- △ **CAUTION:** Electrostatic discharge (ESD) can damage electronic components. Before beginning any procedure, ensure that you are discharged of static electricity by touching a grounded metal object.

To add or replace a memory module:

1. Save your work.
2. Shut down the computer and close the display.

If you are not sure whether the computer is off or in Hibernation, turn the computer on by sliding the power switch. Then shut down the computer through the operating system.

3. Disconnect all external devices connected to the computer.
4. Unplug the power cord from the AC outlet.
5. Turn the computer upside down on a flat surface.
6. Remove the battery from the computer (1).

 **NOTE:** For more information, refer to the section “Inserting or removing the battery,” earlier in this guide.

7. Remove the bottom panel:
 - a. Press the inner release latches (2) on the left and right sides to loosen the bottom panel.
 - b. Pull away the bottom panel (3).

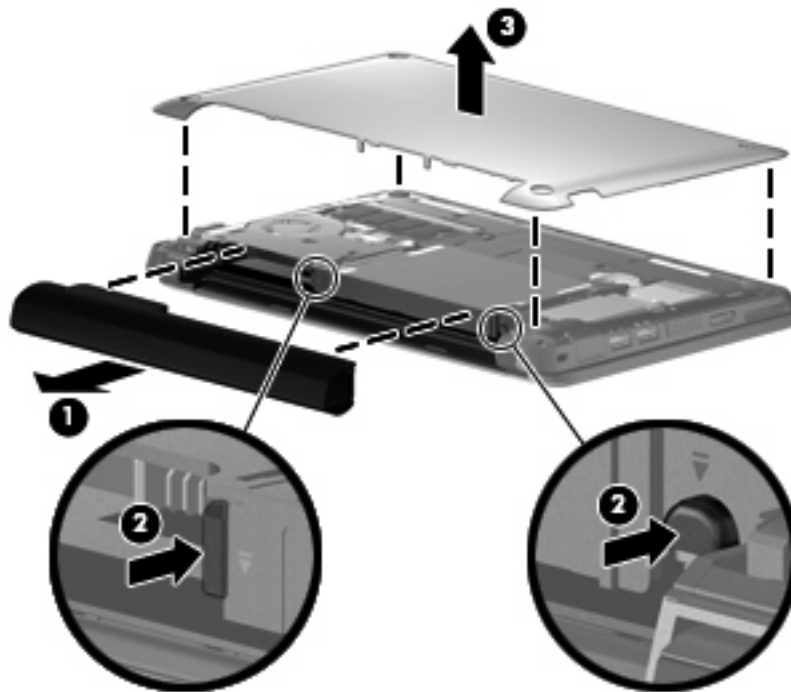

8. Remove the existing memory module:

- a. Pull away the retention clips (1) on each side of the memory module.

The memory module tilts up.

△ **CAUTION:** To prevent damage to the memory module, hold the memory module by the edges only. Do not touch the components on the memory module.

- b. Grasp the edge of the memory module (2), and gently pull the module out of the memory module slot.

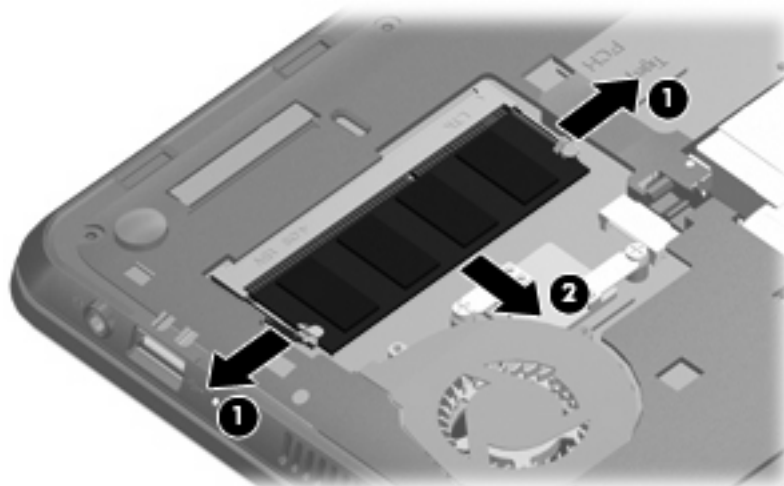

To protect a memory module after removal, place it in an electrostatic-safe container.

9. Insert a new memory module:

△ **CAUTION:** To prevent damage to the memory module, hold the memory module by the edges only. Do not touch the components on the memory module, and do not bend the memory module.

- a. Align the notch (1) in the memory module with the tab in the memory module slot.
- b. With the memory module at a 45-degree angle from the surface of the memory module compartment, press the module (2) into the memory module slot until it is seated.
- c. Gently press the memory module (3) down, applying pressure to both the left and right edges of the memory module, until the retention clips snap into place.

△ **CAUTION:** To prevent damage to the memory module, be sure that you do not bend the memory module.

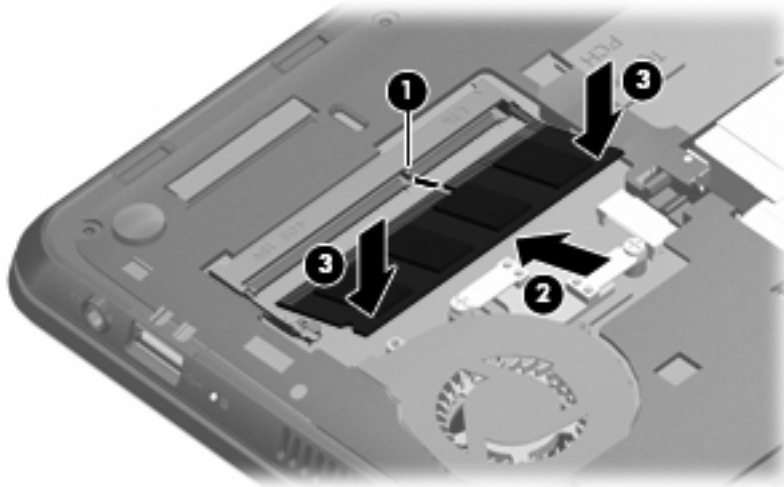

10. Replace the removable bottom panel:

- a. With the battery bay away from you, position the bottom panel at a 45-degree angle from the surface of the computer so that the tabs on the underside of the panel align with the matching slots on the computer (1).
- b. Gently press the bottom panel (2) down, applying pressure to both the left and right edges of the panel, until it snaps into place.

- c. Replace the battery (3).

 **NOTE:** For more information, refer to the section “Inserting and removing the battery,” earlier in this guide.



11. Turn the computer right-side up, and then reconnect external power and external devices.
12. Turn on the computer.

12 Updating software

Updated versions of the software provided with your computer may be available on the HP Web site.

Most software and BIOS updates on the HP Web site are packaged in compressed files called *SoftPaqs*.

Some download packages contain a file named *Readme.txt*, which contains information regarding installing and troubleshooting the file.

To update the software, follow these steps, which are explained in the remainder of this guide:

1. Identify your computer model, product category, and series or family. Prepare for a system BIOS update by identifying the BIOS version currently installed on the computer.

If your computer is connected to a network, consult the network administrator before installing any software updates, especially system BIOS updates.

 **NOTE:** The computer system BIOS is stored on the system ROM. The BIOS initializes the operating system, determines how the computer will interact with the hardware devices, and provides for data transfer among hardware devices, including the time and date.

2. Access the updates on the HP Web site at <http://www.hp.com>.
3. Install the updates.

Updating the BIOS

To update the BIOS, first determine what BIOS version you currently have and then download and install the new BIOS.

Determining the BIOS version

To determine whether available BIOS updates contain later BIOS versions than those currently installed on the computer, you need to know the version of the system BIOS currently installed.

BIOS version information (also known as *ROM date* and *System BIOS*) can be displayed by opening Setup Utility.

To display the BIOS information:

1. Open Setup Utility by turning on or restarting the computer, and then pressing **F10** while the “F10 = BIOS Setup Options” message is displayed in the lower-left corner of the screen.
2. If Setup Utility does not open with the system information displayed, use the arrow keys to select the **Main** menu.

When the Main menu is selected, BIOS and other system information is displayed.

3. To exit Setup Utility, use the arrow keys to select **Exit > Exit Discarding Changes**, and then press **enter**.

Downloading a BIOS update

- △ **CAUTION:** To prevent damage to the computer or an unsuccessful installation, download and install a BIOS update only when the computer is connected to reliable external power using the AC adapter. Do not download or install a BIOS update while the computer is running on battery power or connected to an optional power source. During the download and installation, follow these instructions:

Do not disconnect power from the computer by unplugging the power cord from the AC outlet.

Do not shut down the computer or initiate Sleep or Hibernation.

Do not insert, remove, connect, or disconnect any device, cable, or cord.

To download a BIOS update:

1. Access the page on the HP Web site that provides software for your computer:
Select **Start > Help and Support**, and then select the software and drivers update.
2. Follow the instructions on the screen to identify your computer and access the BIOS update you want to download.
3. At the download area, follow these steps:
 - a. Identify the BIOS update that is later than the BIOS version currently installed on your computer. Make a note of the date, name, or other identifier. You may need this information to locate the update later, after it has been downloaded to your hard drive.
 - b. Follow the instructions on the screen to download your selection to the hard drive.

Make a note of the path to the location on your hard drive where the BIOS update is to be downloaded. You will need to access this path when you are ready to install the update.

 **NOTE:** If you connect your computer to a network, consult the network administrator before installing any software updates, especially system BIOS updates.

BIOS installation procedures vary. Follow any instructions that are displayed on the screen after the download is complete. If no instructions are displayed, follow these steps:

1. Open Windows Explorer by selecting **Start > Computer**.
2. Double-click your hard drive designation. The hard drive designation is typically Local Disk (C:).
3. Using the hard drive path you recorded earlier, open the folder on your hard drive that contains the update.
4. Double-click the file that has an .exe extension (for example, *filename.exe*).

The BIOS installation begins.

5. Complete the installation by following the instructions on the screen.

 **NOTE:** After a message on the screen reports a successful installation, you can delete the downloaded file from your hard drive.

Updating programs and drivers

To download and install software other than a BIOS update, follow these steps:

1. Access the page on the HP Web site that provides software for your computer:
Select **Start > Help and Support**, and then select the software and drivers update.
2. Follow the instructions on the screen to find the software you want to update.
3. At the download area, select the software you want to download and follow the instructions on the screen.

 **NOTE:** Make a note of the path to the location on your hard drive where the software is to be downloaded. You will need to access this path when you are ready to install the software.

4. When the download is complete, open Windows Explorer by selecting **Start > Computer**.
5. Double-click your hard drive designation. The hard drive designation is typically Local Disk (C:).
6. Using the hard drive path you recorded earlier, open the folder on your hard drive that contains the update.
7. Double-click the file that has an .exe extension (for example, *filename.exe*).
The installation begins.
8. Complete the installation by following the instructions on the screen.

 **NOTE:** After a message on the screen reports a successful installation, you can delete the downloaded file from your hard drive.

13 Changing QuickWeb settings

Disabling and enabling QuickWeb

To disable or reenable QuickWeb from within the Windows operating system:

1. Select **Start > All Programs > HP QuickWeb**. The **HP QuickWeb Installer** folder is displayed. Click **HP QuickWeb Configuration Tool**.
2. Select the **Enable QuickWeb** check box.
3. Click **OK**.

 **NOTE:** The HP QuickWeb Configuration Tool can also be accessed by selecting **Start > Control Panel**, and then clicking the **View by** arrow. Select **Large icons** or **Small icons** to locate the HP QuickWeb Configuration Tool.

14 Setup Utility

Starting Setup Utility

Setup Utility is a ROM-based information and customization utility that can be used even when your Windows operating system is not working.

The utility reports information about the computer and provides settings for startup, security, and other preferences.

To start Setup Utility:

- ▲ Open Setup Utility by turning on or restarting the computer, and then pressing **f10** while the “F10 = BIOS Setup Options” message is displayed in the lower-left corner of the screen.

Using Setup Utility

Changing the language of Setup Utility

The following procedure explains how to change the language of Setup Utility. If Setup Utility is not already running, begin at step 1. If Setup Utility is already running, begin at step 2.

1. Open Setup Utility by turning on or restarting the computer, and then pressing **f10** while the “F10 = BIOS Setup Options” message is displayed in the lower-left corner of the screen.
2. Use the arrow keys to select **System Configuration > Language**, and then press **enter**.
3. Use the arrow keys to select a language, and then press **enter**.
4. When a confirmation prompt with your language selected is displayed, press **enter**.
5. To save your change and exit Setup Utility, use the arrow keys to select **Exit > Exit Saving Changes**, and then press **enter**.

Your change goes into effect immediately.

Navigating and selecting in Setup Utility

Because Setup Utility is not Windows based, it does not support the TouchPad. Navigation and selection are by keystroke.

- To choose a menu or a menu item, use the arrow keys.
- To choose an item in a list or to toggle a field, for example an Enable/Disable field, use either the arrow keys or **f5** or **f6**.

- To select an item, press **enter**.
- To close a text box or return to the menu display, press **esc**.
- To display additional navigation and selection information while Setup Utility is open, press **f1**.

Displaying system information

The following procedure explains how to display system information in Setup Utility. If Setup Utility is not open, begin at step 1. If Setup Utility is open, begin at step 2.

1. Open Setup Utility by turning on or restarting the computer, and then pressing **f10** while the “F10 = BIOS Setup Options” message is displayed in the lower-left corner of the screen.
2. Select the **Main** menu. System information such as the system time and date, and identification information about the computer is displayed.
3. To exit Setup Utility without changing any settings, use the arrow keys to select **Exit > Exit Discarding Changes**, and then press **enter**.

Restoring default settings in Setup Utility

The following procedure explains how to restore the Setup Utility default settings. If Setup Utility is not already running, begin at step 1. If Setup Utility is already running, begin at step 2.

1. Open Setup Utility by turning on or restarting the computer, and then pressing **f10** while the “F10 = BIOS Setup Options” message is displayed in the lower-left corner of the screen.
2. Use the arrow keys to select **Exit > Load Setup Defaults**, and then press **enter**.
3. When the Setup Confirmation is displayed, press **enter**.
4. To save your change and exit Setup Utility, use the arrow keys to select **Exit > Exit Saving Changes**, and then press **enter**.

The Setup Utility default settings go into effect when the computer restarts.

 **NOTE:** Your password, security, and language settings are not changed when you restore the factory default settings.

Exiting Setup Utility

You can exit Setup Utility with or without saving changes.

- To exit Setup Utility and save your changes from the current session:

If the Setup Utility menus are not visible, press **esc** to return to the menu display. Then use the arrow keys to select **Exit > Exit Saving Changes**, and then press **enter**.

- To exit Setup Utility without saving your changes from the current session:

If the Setup Utility menus are not visible, press **esc** to return to the menu display. Then use the arrow keys to select **Exit > Exit Discarding Changes**, and then press **enter**.

After either choice, the computer restarts in Windows.

Setup Utility menus

The menu tables in this section provide an overview of the Setup Utility options.

 **NOTE:** Some of the Setup Utility menu items listed in this chapter may not be supported by your computer.

Main menu

Select	To do this
System information	<ul style="list-style-type: none">• View and change the system time and date.• View identification information about the computer.• View specification information about the processor, memory size, and system BIOS.

Security menu

Select	To do this
Administrator password	Enter, change, or delete an administrator password.
Power-On Password	Enter, change, or delete a power-on password.

System Configuration menu

Select	To do this
Language Support	Change the Setup Utility language.
Processor C4 State	Enable/disable the processor C4 sleep state.
Boot Options	Set the following boot options: <ul style="list-style-type: none">• f10 and f12 Delay (sec.)—Set the delay for the f10 and f12 functions of Setup Utility in intervals of 5 seconds each (0, 5, 10, 15, 20).• HP QuickWeb—Enable/disable the QuickWeb Boot menu in Setup Utility.• Internal Network Adapter boot—Enable/disable boot from Internal Network Adapter.• Boot Device Priority—Set the boot device priority for:<ul style="list-style-type: none">◦ Internal hard drive (select models only)◦ USB Floppy◦ USB CD/DVD ROM Drive◦ USB flash drive◦ USB Hard drive

Select	To do this
	<ul style="list-style-type: none">◦ USB Card Reader◦ Network adapter
	NOTE: Only the devices attached to the system appear in the boot order menu.

Diagnostics menu

Select	To do this
Hard Disk Self Test (select models only)	Run a comprehensive self-test on the hard drive.
Memory Test	Run a diagnostic test on the system memory.

Index

A

- AC adapter
 - connecting 16
 - identifying 11
- action keys 5
- administrator password
 - creating 48
 - entering 48
 - managing 48
- airport security devices 66
- antennas 10
- applications key, Windows 5
- audio devices, connecting
 - external 43
- audio functions, checking 43
- audio-in (microphone) jack 8, 39
- audio-out (headphone) jack 8, 39

B

- battery
 - calibrating 20
 - charging 18, 20
 - discharging 19
 - disposing 23
 - identifying 11
 - inserting 17
 - low battery levels 19
 - recharging 22
 - removing 17
 - storing 23
- battery bay, identifying 9
- battery light 18, 19
- battery power 16
- battery release latches 9, 17
- battery temperature 23
- bay, battery 9
- BIOS, updating 73
- Bluetooth device 27
- boot options 79

- boot order 79
- buttons
 - left TouchPad 3
 - right TouchPad 4
 - TouchPad, on/off button 3

C

- cables
 - LAN 26
 - USB 55
 - VGA 44
- calibrating battery 20
- caps lock light, identifying 4
- CD drive 66
- changing Setup Utility
 - language 77
- charging batteries 18, 20
- checking audio functions 43
- components
 - additional hardware 11
 - bottom 9
 - display 8
 - front 5
 - left-side 7
 - right-side 6
 - TouchPad 3
- connecting to a WLAN 31
- Connection Manager icon 27
- connection, external power 16
- cord, power 11
- corporate WLAN connection 31
- critical battery level 20

D

- Diagnostics menu 80
- digital card
 - inserting 53
 - removing 54
- Digital Media Slot, identifying 6
- diskette drive 66

- display switch, identifying 8
- displaying system information 78
- drive media 13
- drives
 - diskette 66
 - external 66
 - hard 66
 - optical 66
- drives, boot order 79
- DVD drive 66

E

- earbuds 8, 39
- encryption 31
- entering a power-on
 - password 49
- entering an administrator
 - password 48
- exiting Setup Utility 78
- external audio devices,
 - connecting 43
- external drive 66
- external monitor port 44
- external monitor port,
 - identifying 7

F

- firewall 31
- fn key 5, 60
- function keys 60

H

- hard drive self test 80
- hard drive, external 66
- hardware, identifying 3
- headphone (audio-out) jack 8, 39
- headphones 8, 39
- Hibernation
 - exiting 14

- initiated during critical battery level 20
 - initiating 14
 - hotkeys
 - description 60
 - using 61
 - HP Connection Manager
 - software 28
 - HP Mobile Broadband Module 33
 - HP Mobile Broadband, disabled 33
 - hubs 55
- I**
- icons
 - Connection Manager 27
 - network 27
 - wired network 27
 - wireless 27
 - internal display switch, identifying 8
 - internal microphone, identifying 9, 38
 - Internet connection setup 30
- J**
- jacks
 - audio-in (microphone) 8, 39
 - audio-out (headphone) 8, 39
 - RJ-45 (network) 7
- K**
- keyboard hotkeys, identifying 60
 - keys
 - action 5
 - fn 5
 - Windows applications 5
 - Windows logo 5
- L**
- labels
 - Microsoft Certificate of Authenticity 12
 - regulatory 12
 - service tag 11
 - language support 79
 - latches, battery release 9
 - Left TouchPad button, identifying 3
 - lights
 - caps lock 4
 - TouchPad 4
 - webcam 8
 - local area network (LAN)
 - cable required 26
 - connecting cable 26
 - low battery level 19
- M**
- Main menu 79
 - managing a power-on password 49
 - managing an administrator password 48
 - memory module
 - inserting 69
 - removing 69
 - memory test 80
 - microphone (audio-in) jack 8, 39
 - monitor, connecting 44
 - mouse, external
 - connecting 59
 - setting preferences 57
 - multimedia components, identifying 37
 - multimedia software
 - installing 42
 - using 42
 - mute action key, identifying 38
- N**
- navigating in Setup Utility 77
 - network cable
 - connecting 26
 - noise suppression circuitry 26
 - network icon 27
 - network jack, identifying 7
 - noise suppression circuitry, network cable 26
- O**
- operating system 23
 - optical drive 66
- P**
- passwords
 - administrator 48
 - power-on 48
 - set in Setup Utility 47
 - set in Windows 47
- ports**
- external monitor 44
 - USB 6, 8, 55
- power**
- connecting 16
 - power connector, identifying 7
 - power cord, identifying 11
 - power-on password
 - creating 49
 - entering 49
 - managing 49
 - Processor C4 State 79
 - product name and number, computer 11
 - programs, updating 75
 - projector, connecting 44
 - public WLAN connection 31
- Q**
- QuickWeb
 - disabling 76
 - enabling 76
 - Setup Utility 79
- R**
- readable media 13
 - regulatory information
 - HP Mobile Broadband Module serial number 12
 - regulatory label 12
 - wireless 12
 - release latches
 - battery 9, 18
 - restoring default settings 78
 - right TouchPad button, identifying 4
 - RJ-45 (network) jack, identifying 7
- S**
- security cable slot 7
 - Security menu 79
 - security, wireless 30
 - selecting in Setup Utility 77
 - serial number, computer 11
 - service tag 11
 - setup of WLAN 30
 - Setup Utility, passwords set in 47
 - setup, computer 3
 - shut down 23

- SIM
 - inserting 33
 - removing 34
- Sleep
 - exiting 13
 - initiating 13
- software
 - HP Connection Manager 28
 - installing 42
 - multimedia 42
 - Windows Media Player 42
- speakers 5
- speakers, identifying 38
- storing battery 23
- System Configuration menu 79
- system information 79

T

- temperature 23
- TouchPad
 - buttons 3
 - identifying 3
- TouchPad light, identifying 4
- TouchPad on/off button,
 - identifying 3
- TouchPad scroll zone,
 - identifying 3
- traveling with the computer 23
- turning off the computer 23

U

- unresponsive system 23
- USB cable, connecting 55
- USB devices
 - connecting 55
 - description 55
 - removing 55
- USB hubs 55
- USB ports, identifying 6, 8, 55

V

- vents, identifying 7
- volume down action key,
 - identifying 39
- volume up action key,
 - identifying 38
- volume, adjusting 39

W

- webcam light, identifying 8, 38
- webcam, identifying 9, 38
- Windows applications key,
 - identifying 5
- Windows logo key, identifying 5
- Windows, passwords set in 47
- wired network icon 27
- wireless action key, identifying 28
- wireless antennas 10
- wireless controls
 - button 28
 - operating system 28
- wireless icon 27
- wireless light, identifying 28
- wireless network (WLAN)
 - connecting 31
 - corporate WLAN
 - connection 31
 - equipment needed 30
 - functional range 32
 - public WLAN connection 31
 - security 30
 - wireless network, connecting 27
- WLAN antennas, identifying 11
- WLAN device 27
- writable media 13
- WWAN antennas, identifying 10

